

Installation/Owner's Manual

1803 / 1808 / 1810 Telephone Entry System

Use this manual for circuit board 1862-010 Revision O or higher.

1800-060 Issued 7-19

Control a main entry point plus an additional entry point.

1803

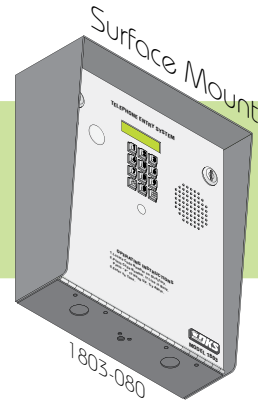
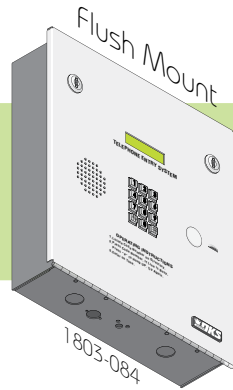

1808

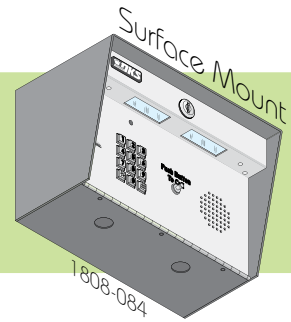
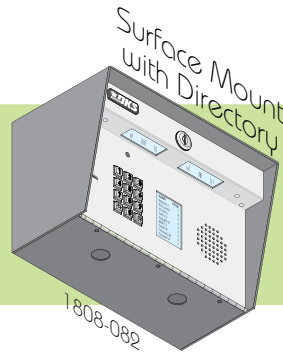

1810

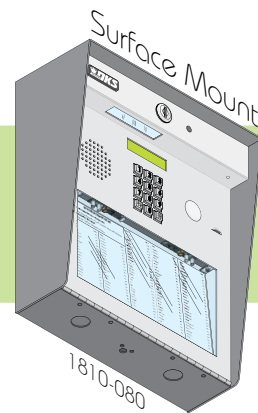
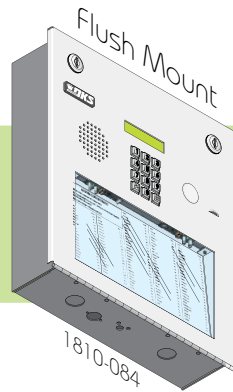

Date Installed: _____

Installer/Company Name: _____

Model Number _____

Phone Number: _____

Circuit Board
Serial Number
and Revision Letter: _____

Leave Manual with Owner

Copyright 2019 DoorKing®, Inc. All rights reserved.

Version B



Conforms To UL STD 294
Certified To CAN/ULC-S319-05



QUICK GUIDE: Terminal Descriptions



Located in the upper left corner of circuit board.

Switch Input 2 Terminal Non-Removable

A closure between these terminals will cause **Relay 2** to activate for the programmed strike time or dial a preprogrammed phone number (see section 3.1.7).

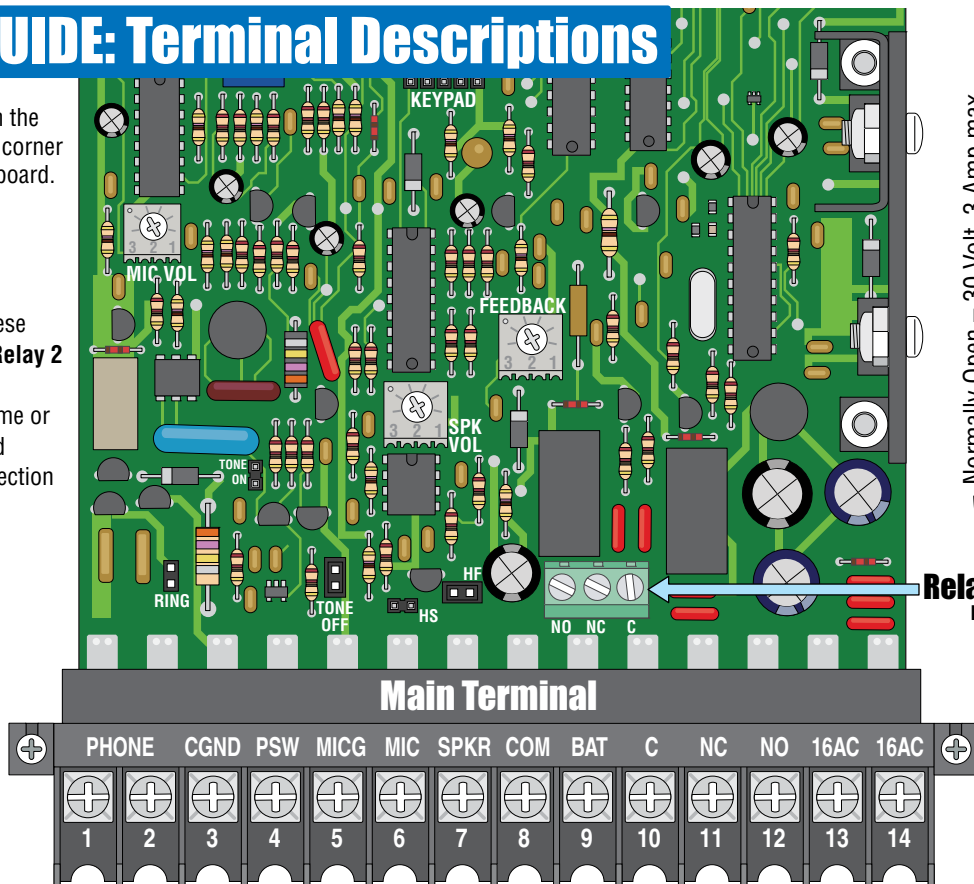

Main Terminal

+	PHONE	CGND	PSW	MICG	MIC	SPKR	COM	BAT	C	NC	NO	16AC	16AC	+
	1	2	3	4	5	6	7	8	9	10	11	12	13	14

Phone Line Connection
Tip
Phone Line Connection
Ring

800 ft. max. with 24 AWG wire.
1600 ft. max. with 22 AWG wire.
(Wiring **MUST** be twisted and isolated from the ground)

Earth Ground Only (See Section 2.1.3). **NOT** a low voltage common.

Switch Input 1. A closure between terminals 4 and 8 will cause **Relay 1** to activate for the programmed strike time or dial a preprogrammed phone number — see section 3.1.7.

Microphone ground Input (White Wire).

Microphone Input (Green Wire).

Speaker Output (Purple Wire).

Common for Switch Input 1 terminal #4, speaker, Standby Battery NEGATIVE

Standby Battery POSITIVE (12 VDC, .7 Ah, SLA) (connect negative to terminal 8)

Relay 1 Common

Relay 1 Normally Closed — 30 Volt, 3 Amp max.

Relay 1 Normally Open — 30 Volt, 3 Amp max.

16 VAC Input Power
100 ft. max. with 18 AWG wire.
200 ft. max. with 16 AWG wire.
16 VAC Input Power
Install ferrite filter on these wires - see section 2.1.5.

Normally Open — 30 Volt, 3 Amp max.
Normally Closed — 30 Volt, 3 Amp max.
Common — 30 Volt, 3 Amp max.

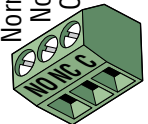

Relay 2 Terminal Non-Removable

UL 294 Tamper Switch

Located under microphone board (See Section 1.7).

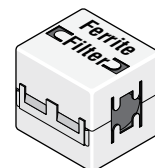
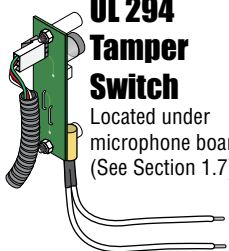

Do Not Connect Power To A Receptacle Controlled By A Switch.

See page 21 for terminal wiring.

Overview for System Programming

	Page #	Section	Command	Factory Setting
Section 3.1 General Programming				
Master Code	26	3.1.1	Master Switch ON	NO Factory setting
Single or Multiple Systems	28	3.1.2	* 04	0 (single)
Relay Strike Time	28	3.1.3	* 03	Relay 1= 01 (1 sec) Relay 2= 01 (1 sec)
“Tone Open” Sound ON or OFF	28	3.1.4	* 17	1 (tone ON)
Talk Time	28	3.1.5	* 08	060 (60 sec)
Tone Open Numbers	29	3.1.6	* 05	Relay 1= 9 8 7 6 Relay 2= 5 4 3 2
Programming Switch Input 1 and Switch Input 2	29	3.1.7	* 23	0 (relays activate)
Number of Rings Before Telephone Entry System will Answer	29	3.1.8	* 18	02 (two rings)
PBX Line Access Code Programming	30	3.1.9	* 21	
Star Key (*) Function	30	3.1.10	* 27	0 (hang-up)
Keypad Function (DTMF Programming)	30	3.1.11	* 26	0 (all numbers)
System to Stay On-Line or Hang-Up after Touch-Tone Number Pressed	30	3.1.12	* 28	1-relays hang-up
Automatic Hang-Up Function	31	3.1.13	* 40	1 (hang-up after 5 sec of dial-tone)
Section 3.2 Directory Code and Phone Number Programming				
Programming the Directory Code Length	32	3.2.1	* 20	3 (3 digits)
# Key - Insert an Amount of “Pause Time” Between Phone Number Digits	32	3.2.2	* 42	0 (0 sec)
Programming Phone Numbers - Up to 16-Digits	33	3.2.3	* 01	
Deleting Individual Phone Number	33	3.2.4	* 01	
Deleting ALL Phone Numbers CAUTION	34	3.2.5	* 22	
Display / DELETE Phone Numbers with UNKNOWN Directory Codes	34	3.2.6	* 25	
Display Phone Numbers with KNOWN Directory Codes	34	3.2.7	* 06	
7-Digit Phone # - Limited Use - 7-Digit Phone Number Capability CAUTION	35	3.2.8	* 44	0 (No)
16-Digit Phone Number Capability CAUTION	35	3.2.9	* 45	1 (Yes)
Programming 7-Digit Phone Numbers	36	3.2.10	* 01	
Programming Area Codes (Area Code Reference Numbers)	36	3.2.11	* 24	
Programming Phone Numbers WITH Area Code Reference Numbers	37	3.2.12	* 41	
Deleting Individual 7-Digit Phone Number	37	3.2.13	* 01	
<div style="border: 1px solid black; padding: 2px; display: inline-block;"> These sections are NOT used for Factory Set 16-Digit Phone Number Programming </div>				
Section 3.3 Entry Code Programming				
Programming Four-Digit Entry Code	38	3.3.1	* 02	
Delete Individual Four-Digit Entry Code	38	3.3.2	* 14	
Delete ALL Four-Digit Entry Codes CAUTION	38	3.3.3	* 00	
Four-Digit Entry Code Divide Number to Activate Relays	38	3.3.4	* 12	9999
Four-Digit Entry Code (Reverse Relay Activation ONLY)	39	3.3.5	* 19	
Programming Five-Digit Entry Code	39	3.3.6	* 09	
Delete Individual Five-Digit Entry Code	39	3.3.7	* 10	
Delete ALL Five-Digit Entry Codes CAUTION	39	3.3.8	* 11	
Five-Digit Entry Code Divide Number to Activate Relays	39	3.3.9	* 13	9999
Section 3.4 Time Functions Programming				
Programming Time Clock	40	3.4.1	* 33	
Automatic Relay Activation Time Zones	40	3.4.2	* 35	
Four-Digit Entry Codes Time Zone	41	3.4.3	* 36	
Five-Digit Entry Codes Time Zone	42	3.4.4	* 37	
“Flash Entry Codes” Active for ONE-DAY ONLY	42	3.4.5	* 15	

SPECIFICATIONS

1803 / 1808 / 1810 Telephone Entry Systems, Circuit Board 1862-010 REV 0 or Higher.

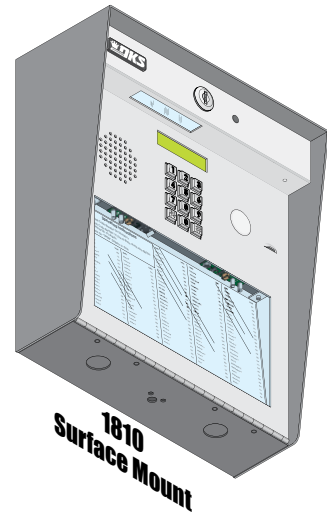
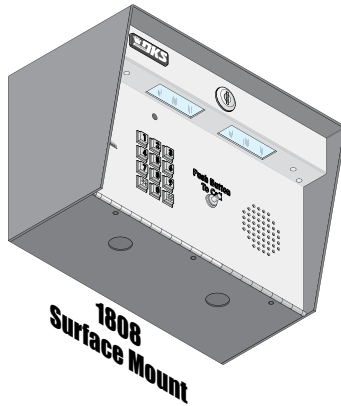
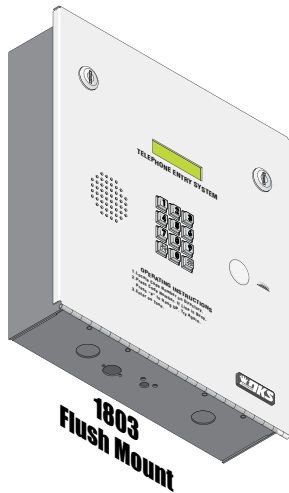

Features

- **THREE different types** of connection options, DKS Cellular, VoIP over the Internet or POTS telephone line.
- Provides service for up to **600 residents** but can be reprogrammed to provide service for up to **1000 residents**.
- System can be programmed from the front keypad.
- System can be programmed remotely using a touch-tone telephone.
- System keypad will emit DTMF tones after a call is answered allowing the system to be used with auto-attendants, answering machines, etc.
- Directory codes can be set from 1 to 4 digits in length and can be randomly assigned.
- Up to 16-digit phone number dialing with optional pauses between digits when necessary.
- Two internal relays allow the system to control a main entry point plus an additional entry point.
- Built in time clock provides hold open time zones, entry code time zones and “Flash” entry codes.
- 5-digit entry codes available for special needs.
- 2 programmable switch inputs can be set to activate a relay or dial a preprogrammed phone number.

Included with the system is an extra random keyed cabinet lock. If desired, for added security against unauthorized entry into the system, the standard lock may be replaced with the random lock.
Note: DoorKing cannot replace this specific lock or keys if lost.

DoorKing, Inc. reserves the right to make changes in the products described in this manual without notice and without obligation of DoorKing, Inc. to notify any persons of any such revisions or changes. Additionally, DoorKing, Inc. makes no representations or warranties with respect to this manual. This manual is copyrighted, all rights reserved. No portion of this manual may be copied, reproduced, translated, or reduced to any electronic medium without prior written consent from DoorKing, Inc.

TABLE OF CONTENTS

Important Notices	FCC - United States, DOC - Canada	3
Glossary		3
General Information	Installation Guidelines and Safety Information	4
SECTION 1 - INSTALLATION		5
1.1 General Installation		5
1.1.1	Remove Components from Enclosure	6
1.2.1	Install Enclosure for 1803 & 1810	7
1.2 1803 & 1810 Surface Mount Dimensions		8
1.2.1	Surface Mount Recess Kit Installation for 1803 & 1810	9
1.3 1803 & 1810 Flush Mount Dimensions		10
1.3.1	Flush Mount Kit Installation for 1803 & 1810	11
1.3.2	Self-Standing Lighted Kiosk for 1803 & 1810	12
1.3.3	Flush Mount Surface Mounting Kit Installation for 1803 & 1810	13
1.4 1808 Dimensions and Installation		14
1.5 Memory Chip Replacement		15
1.6 Postal Lock Installation		16
1.7 UL 294 Compliant Tamper Switch		17
SECTION 2 - WIRING		18
2.1 Wiring Guidelines		18
2.1.1	Power	18
2.1.2	Wire Runs	19
2.1.3	Grounding	19
2.1.4	Surge Suppression	19
2.1.5	Ferrite Filter	19
2.2 Terminal Descriptions		20
2.3 Telephone Entry System Wiring and Adjustments		21
2.3.1	Speaker Volume, Microphone and Feedback	22
2.3.2	Click Sensitivity - Use for Rotary-Dial Phones ONLY	22
2.3.3	LCD Display Contrast for 1803 & 1810	22
2.3.4	Master Code Switch	23
2.3.5	Ring Pin Jumper	23
2.3.6	Hands Free - Hand Set Jumper	23
2.4 Phone (Voice) Connection Options		24-25
SECTION 3 - PROGRAMMING		26
3.1 General Programming		26
3.1.1	Master Code	26
Overview for System Programming		27
3.1.2	Single or Multiple Systems	28
3.1.3	Relay Strike Time	28
3.1.4	"Tone Open" Sound ON or OFF	28
3.1.5	Talk Time	28
3.1.6	Tone Open Numbers	29
3.1.7	Programming Switch Input 1 and Switch Input 2	29
3.1.8	Number of Rings Before Telephone Entry System will Answer	29
3.1.9	PBX Line Access Code Programming	30
3.1.10	Star Key Function	30
3.1.11	Keypad Function (DTMF Tone Programming)	30
3.1.12	System to Stay On-Line or Hang-Up after Touch Tone Number Pressed	30
3.1.13	Automatic Hang-Up Function	31

TABLE OF CONTENTS

SECTION 3 - PROGRAMMING Continued

3.2 Phone Number Programming 32

	3.2.1	Programming the Directory Code Length	32
	3.2.2	# Key - Insert an Amount of "Pause Time" Between Phone Number Digits	32
	3.2.3	Programming Phone Numbers - Up to 16-Digits	33
	3.2.4	Deleting Individual Phone Number	33
	3.2.5	Deleting ALL Phone Numbers	34
	3.2.6	Display / Delete Phone Numbers with UNKNOWN Directory Codes	34
	3.2.7	Display Phone Numbers with KNOWN Directory Codes	34
	3.2.8	7-Digit Phone Number Capability	35
	3.2.9	16-Digit Phone Number Capability	35
NOT used for Factory Set 16-Digit Phone Number Programming	3.2.10	Programming 7-Digit Phone Numbers	36
	3.2.11	Programming Area Codes (Area Code Reference Numbers)	36
	3.2.12	Programming Area Codes WITH Area Code Reference Numbers	37
	3.2.13	Deleting Individual 7-Digit Phone Number	37

3.3 Entry Code Programming 38

	3.3.1	Programming Four-Digit Entry Code	38
	3.3.2	Delete Individual Four-Digit Entry Code	38
	3.3.3	Delete ALL Four-Digit Entry Codes	38
	3.3.4	Four-Digit Entry Code Divide Number to Activate Relays	38
	3.3.5	Four-Digit Entry Code (Reverse Relay Activation ONLY)	39
	3.3.6	Programming Five-Digit Entry Code	39
	3.3.7	Delete Individual Five-Digit Entry Code	39
	3.3.8	Delete ALL Five-Digit Entry Codes	39
	3.3.9	Five-Digit Entry Code Divide Number to Activate Relays	37

3.4 Time Functions Programming 40

	3.4.1	Programming Time Clock	40
	3.4.2	Automatic Relay Activation Time Zones	40
	3.4.3	Four-Digit Entry Codes Time Zone	41
	3.4.4	Five-Digit Entry Codes Time Zone	42
	3.4.5	"Flash Entry Codes" Active for ONE-DAY ONLY	42

SECTION 4 - SYSTEM OPERATING INSTRUCTIONS 43

4.1 General Instructions 43

	4.1.1	Guest Instructions	43
	4.1.2	Responding to a Guest Call	43
	4.1.3	Using an Entry Code	43

4.2 System Administrator 44

	4.2.1	Remote Programming (Touch-Tone Phone)	44
	4.2.2	Remote Relay Activation	44
	4.2.3	Remote Relay Check	44
	4.2.4	Remote Entry Code Time Zone Enable / Disable	45
	4.2.5	Remote Automatic Relay Time Zone Enable / Disable	45

4.3 Miscellaneous Operating Instructions 46

	4.3.1	Switch Input 1 & 2 Switch Operation	46
	4.3.2	Talk Time	46
	4.3.3	Phone Line Sharing for Multiple Telephone Entry Systems	46
	4.3.4	Connection to a PBX	46
	4.3.5	Areas with 10-Digit Dialing	46

SECTION 5 - MAINTENANCE 47

5.1 Replacement Parts 47

5.2 Troubleshooting 47-48

5.3 Accessories 49

Wiring Schematic 49

SECTION 6 - LOG TABLES 50-52

RESIDENT INSTRUCTIONS 53

Important Notices

FCC – United States

This equipment has been tested and found to comply with the limits for a class A digital device, pursuant to Part 15 of the FCC Rules and Regulations. These limits are designed to provide reasonable protection against harmful interference when the equipment is operated in a commercial environment. This equipment generates, uses, and can radiate radio frequency energy and, if not installed and used in accordance with the instruction manual, may cause harmful interference to radio communications. Operation of this equipment in a residential area is likely to cause harmful interference in which case the user will be required to correct the interference at his own expense.

FCC Registration Number: **DUF6VT-12874-0T-T**

DOC - Canada

The Canadian Department of Communications label identifies certified equipment. This certification means that the equipment meets certain telecommunications network protective, operational, and safety requirements. The Department does not guarantee the equipment will operate to the users satisfaction.

Before installing this equipment, users should ensure that it is permissible to be connected to the facilities of the local telecommunications company. The equipment must also be installed using an acceptable means of connection. The customer should be aware that compliance with the above conditions may not prevent degradation of service in some situations.

Repairs to certified equipment should be made by an authorized Canadian maintenance facility designated by the supplier. Any repairs or alterations made by the user to this equipment, or equipment malfunctions, may give the telecommunications company cause to request the user to disconnect the equipment.

Users should ensure, for their own protection, that the electrical ground connections of the power utility, telephone lines, and internal metallic water pipe system, if present, are connected together. This precaution may be particularly important in rural areas.

CAUTION: Users should not attempt to make such connections themselves, but should contact the appropriate electric inspection authority, or electrician, as appropriate.

DOC Registration Number: **1736 4528 A**

Notice:

The Load Number (LN) assigned to each terminal device denotes the percentage of the total load to be connected to a telephone loop which is used by the device, to prevent overloading. The termination on a loop may consist of any combination of devices subject only to the requirement that the sum of the load numbers of all the devices does not exceed 100.

Notice:

DoorKing does not provide a power transformer on units sold outside of the United States. Use only transformers that are listed by a recognized testing laboratory to power the telephone entry system. **An Inherently Protected Transformer must be used to power this device.** The Telephone Entry systems require a 16.5-volt, 20 VA transformer.

Listing:

This product has been tested to and found to be in compliance with the UL 294 Safety Standard and Certified to CAN/ULC-S319-05 by Intertek Testing Services NA Inc. (a Nationally Recognized Testing Laboratory) and is ETL listed.

Performance Levels

Destructive Attack:	Level I
Line Security:	Level I
Endurance:	Level IV
Standby Power:	Level I (Level II with 12 VDC, .7 Ah, SLA battery, required
Single Point Locking Device with Key Locks:	Level I for Canadian certification)

Glossary

ACCESS CONTROL SYSTEM: A collection of means, measures and specific practices that when combined, form or compose a systematic approach, which enables an authority to control access to areas and resources in a given physical facility. An access control system, within the field of physical security, is generally seen as the second layer in the security of a physical structure.

ALARM: A condition indicating a state of alert or tamper detection.

ALARM SIGNAL: A transmission of an alarm condition or alarm report.

CONTROLLED AREA: A room, office, building, facility, premises, or grounds to which access is monitored, limited, or controlled.

EQUIPMENT: Any part of an electronic access control system, such as access control units, reader interface modules, access point actuators, access point sensors, keypads, and the like.

PROTECTED AREA: A room, office, building, facility, premise or grounds to which access is monitored, and limited and/or controlled, whereby the authorized person of the Access Control System may grant access to non-authorized persons.

RESTRICTED AREA: A room, office, building, facility, premise or grounds to which access is monitored, and limited and strictly controlled, whereby only the administrator of the Access Control System shall issue credentials that will lead to access.

General Information

- Prior to beginning the installation of the telephone entry system, we suggest that you become familiar with the instructions, illustrations, and wiring guidelines in this manual. This will help insure that you installation is performed in an efficient and professional manner.
- The proper installation of the telephone entry panel is an extremely important and integral part of the overall access control system. Check all local building ordinances and building codes prior to installing this system. Be sure your installation is in compliance with local codes.
- When used to control a door or pedestrian gate, try to locate the telephone entry system as near as possible to the entry point. The unit should be mounted on a rigid wall to prevent excessive shock and vibration from closing doors or gates. Continuous vibration and shock from slamming doors or spring-loaded pedestrian gates will damage the circuit board. **Under no circumstances should the unit be mounted directly to a moving door or gate.**
- **ADA mounting requirements for door control (Ref: ICC/ANSI A117.1-2009).** The requirements below apply **ONLY** when the telephone entry system is being used to control entry through **A PUBLIC DOOR ONLY**. If this system is used to control entry through a **vehicular gate** or **private entrance**, the dimensions noted below **do not apply**.

1. Unobstructed Forward Reach. Where a clear floor or ground space allows only a forward approach to an object and is **unobstructed**, mounting height shall be a minimum of **15 inches** (381 mm), and a maximum of **48 inches** (1.22 m), above the floor or ground to the operable controls.

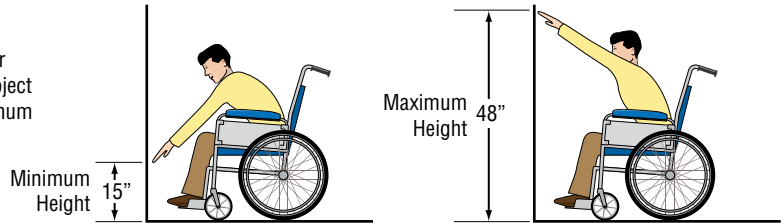

2. OBSTRUCTED HIGH Forward Reach. If the high forward reach is over an obstruction, reach and clearances shall be as shown. **NOTE: If the height of a control is 48" maximum, then the length of the obstruction must be 20" or less. If the height of a control is 44" maximum, then the length of the obstruction may be increased to 25" or less.**

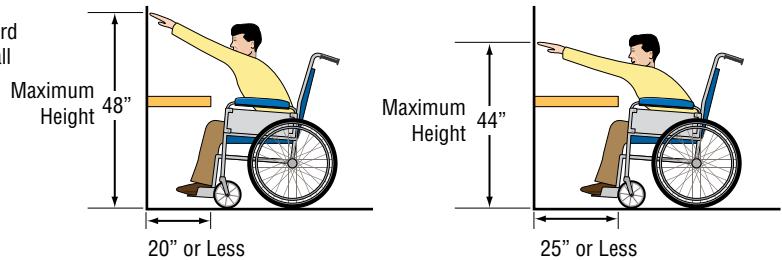

3. Unobstructed Side Reach. Where a clear floor or ground space allows a parallel approach to an object and the side reach is **unobstructed**, and the edge of the clear floor space is **10 inches** (255 mm) maximum from the object, mounting height shall be a minimum of **15 inches** (380 mm), and a maximum of **48 inches** (1.22 m), above the floor or ground to the operable controls.

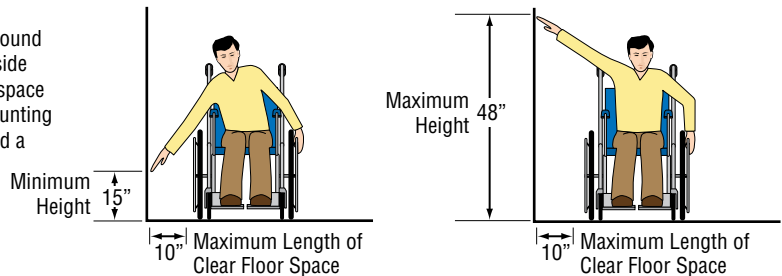

4. OBSTRUCTED HIGH Side Reach. If the side reach is over an obstruction **10 inches or less**, mounting height shall be a maximum of **48 inches** (1.21 m) above the floor or ground to the operable controls. If the side reach is over an obstruction **greater than 10 inches, but less than 24 inches**, mounting height shall be a maximum of **46 inches** (1.17 m) above the floor or ground to the operable controls.

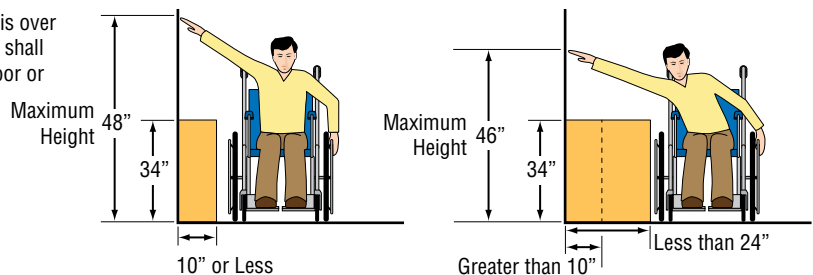

- **When used to control a vehicular gate with an automatic gate operator, the telephone entry system must be mounted a minimum of six (6) feet away from the gate and gate operator, or in such a way that a person cannot operate the entry system and/or touch the gate or gate operator at the same time.**
- Be sure that the system is installed so that it is not directly in the traffic lane. Goose neck mounting post and kiosks work well for these type systems. When planning where to locate the system, take into consideration traffic lane layouts, turn around lanes for rejected access, conduit runs, power availability, etc.
- Environmental factors must also be taken into account. Surface mount units are designed for direct outdoor installations, however it is preferable to protect them from direct exposure to driven rain or snow whenever possible. Flush mount units must be protected from direct exposure to the elements.
- This telephone entry system contains a number of static sensitive components that can be damaged or destroyed by static discharges during installation or use. Discharge any static prior to removing the circuit board from the lobby panel by touching a proper ground device.
- **Instruct the end user to read and follow these instructions. Instruct the end user to never let children play with or operate any access control device. This Owner's Manual is the property of the end user and must be left with them when installation is complete.**

SECTION 1 - INSTALLATION

Prior to installing the telephone entry system, we suggest that you become familiar with the instructions, illustrations, and wiring guidelines in this manual. This will help insure that your installation is performed in an efficient and professional manner.

First you must determine how you would like to connect your telephone entry system for voice communication. The method **you choose** is dependent on the type of connection available at the entry system location. There are **THREE types** of connections:
(See **Section 2.4 Phone (Voice) Connection Options** for more information)

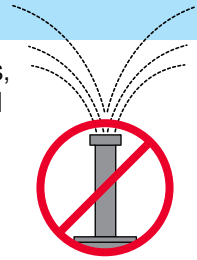

DO NOT install the telephone entry system next to landscape sprinklers or in any area that may expose the system to direct driven water.

- 1 Wireless connection** – uses **DKS cellular** (Voice ONLY) service.
- 2 Network cable connection** – uses **DKS VoIP over the Internet** or **third party providers** of your own choosing.
- 3 Telephone line connection** – uses a **POTS** telephone line.

Note: After **choosing** your connection type, you may need to **purchase additional equipment** or devices **before** your installation can be completed.

1.1 General Installation

There are 2 different styles of the telephone entry systems (Surface mounts and Flush mounts-1803/1810 only), and different ways to mount them (On a wall, in a wall, attached to a architectural style post, kiosk, etc). Models will **ALL** need power and communication wires run to them in conduit or inside a architectural style post. Feed all of the wires through the back or bottom of the entry system using the existing knock-outs provided in the enclosures. **DO NOT** make any new holes in the enclosure to feed wires through. Keep **ALL** the entry system's wires away from any existing high voltage power wires a minimum of 6" to help prevent any noise and hum pickup in the system's phone line. The system **MUST** also be **properly grounded** to function correctly.

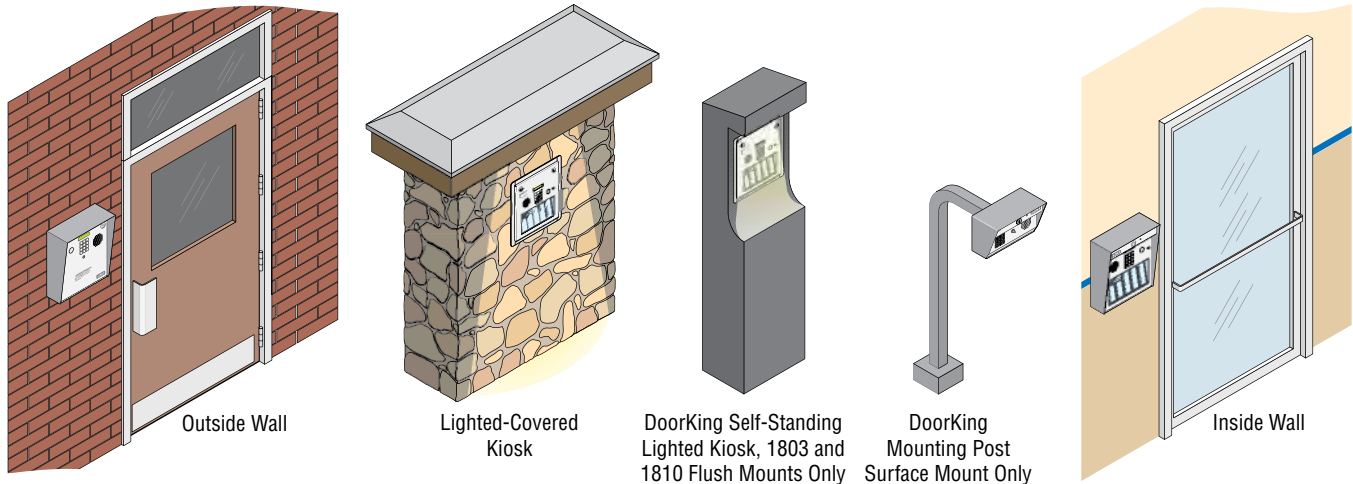

WARNING If this telephone entry system is used to control a vehicular gate with an automatic gate operator, the telephone entry system must be mounted a minimum of six (6) feet away from the gate and gate operator, or in such a way that the user cannot come into contact with the gate or gate operator when using this entry system.

The telephone entry system contains static sensitive components that can be damaged or destroyed by static discharges during installation. **Discharge any static prior to removing the circuit board by touching a proper ground device.** GREAT care must be taken after removing the components from the enclosure to protect them throughout the installation. Carelessness on your part is **NOT** covered under warranty.

Make sure **ALL** dirt, metal or wood debris is removed from inside the enclosure after mounting it. A thorough cleaning of the enclosure is needed before re-installing the components back into the system and wiring it. Any debris left inside could damage the control board and cause the telephone entry system to malfunction during operation.

Included with the system is an extra random keyed cabinet lock. If desired, for added security against unauthorized entry into the system, the standard lock may be replaced with the random lock. Note: DoorKing cannot replace this specific lock or keys if lost.

1.1.1 Remove Components from Enclosure

There are 2 different styles of telephone entry systems - Surface mounts and Flush mount. The basic component removal is the same for all models, 1803 surface mount is shown as an example.

1. Disconnect the keypad ribbon cable from the circuit board.
2. Remove the screw from the top of the circuit board.
3. **GENTLY** remove the circuit board by pulling it out of the main terminal.
4. Remove the two screws from the main terminal and remove the ground wire locknut.
5. Remove the locknuts from the faceplate hinge.
6. Remove the faceplate, main terminal (still wired), store them in a **Safe Place** until they need to be re-installed.
7. Proceed to section 1.2.1 for 1803 & 1810 models. Go to section 1.4 for 1808 model.

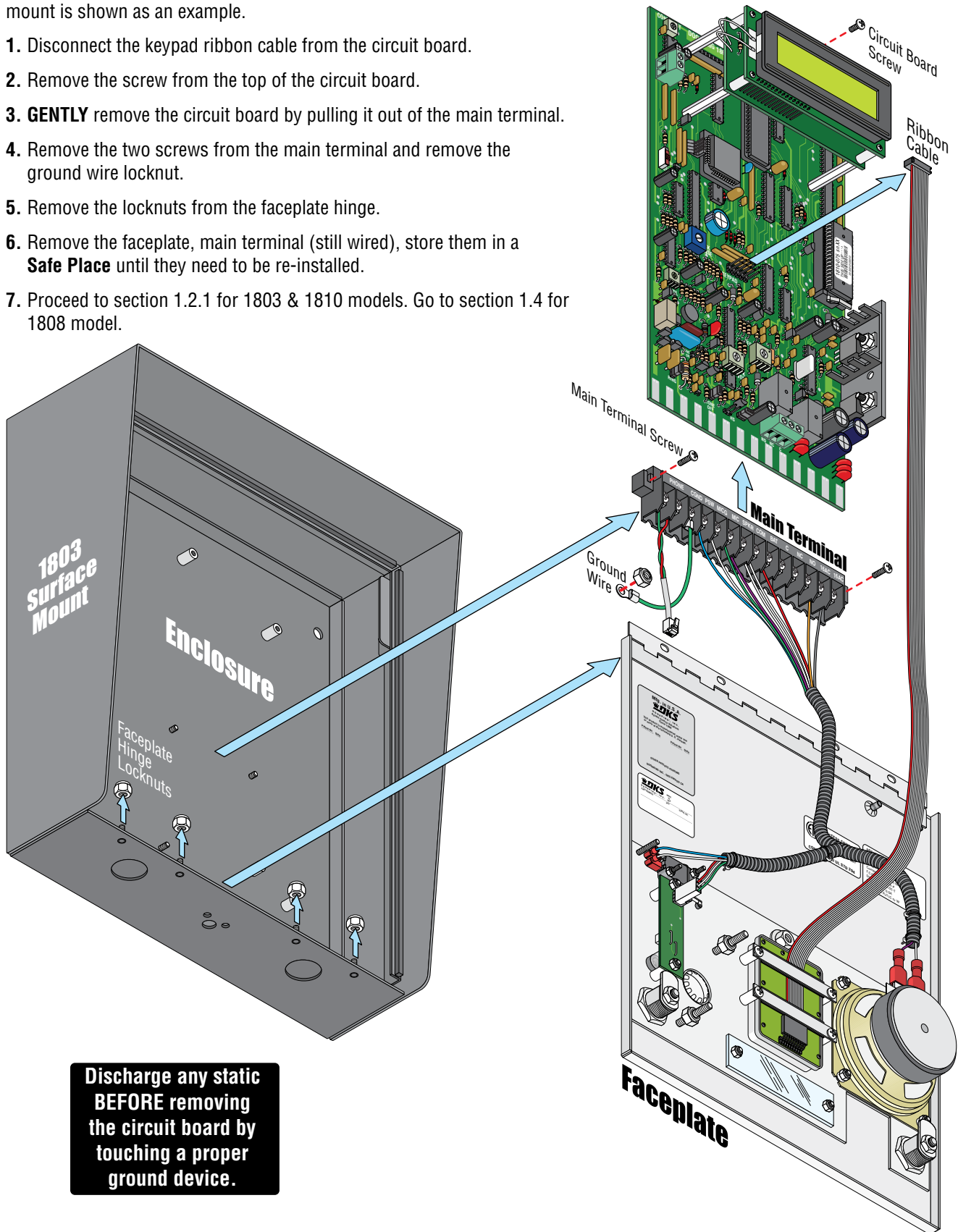

1.1.2 Install Enclosure for 1803 & 1810

There are 2 different styles for the 1803 & 1810 - surface and flush mount. The illustrations below show typical installations but specific installations can vary from this.

1. Mount the enclosure using the mounting holes provided in the corners (see sections 1.2 and 1.3 for your chosen model dimensions including kit installations). Be sure that mounting screws (Not supplied) do not protrude into the enclosure where they could cause a short on the back of the circuit board. Make any necessary conduit connections through the back or bottom of the enclosure using the existing conduit knock-outs. **DO NOT** make any new conduit holes in the enclosure.
2. Route all wiring through conduit or architectural post (not supplied) into enclosure.
3. Clean out the enclosure. Make sure that all dirt, metal and/or wood debris is removed.
4. Re-install components back into the enclosure (Reverse section 1.1.1 steps on previous page). Use the wiring schematics in the back of this manual to help re-install the components if necessary. **DO NOT** apply any power at this time.

Mount to an Architectural Mounting Post

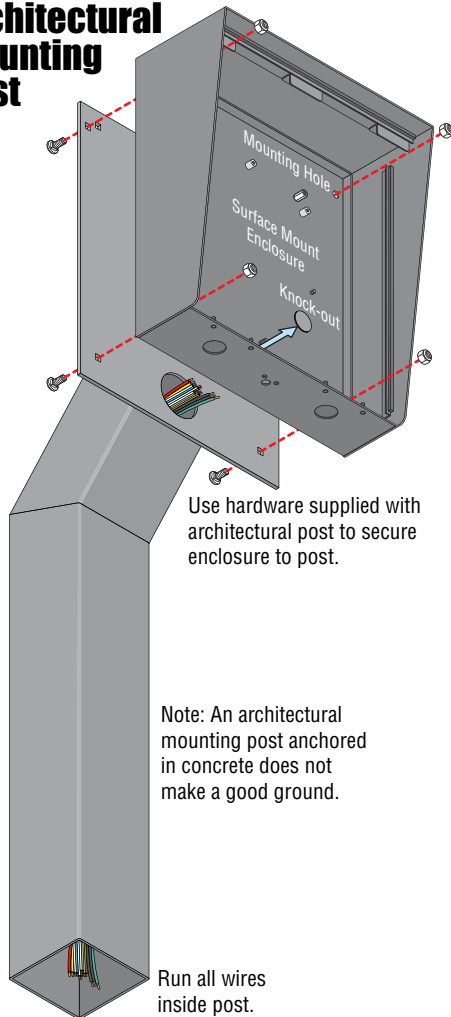

Mount ON a Surface

(See sections 1.2).

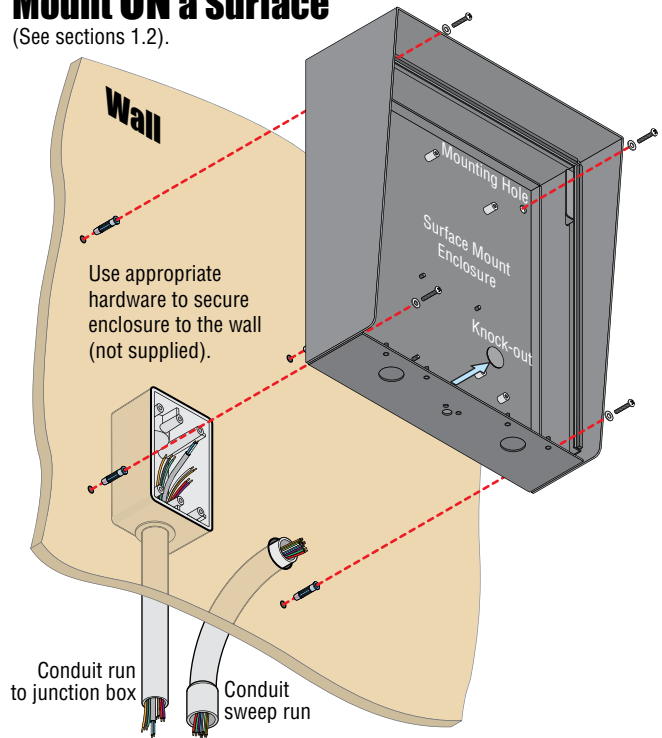

Examples of conduit runs that may be used, depending on how you choose to run the wiring. Some installations will allow the conduit to be run outside the wall and connect to the bottom of the enclosure but this is generally NOT recommended.

Mount IN a Surface

(See sections 1.2.1 and 1.3.1 and 1.3.2).

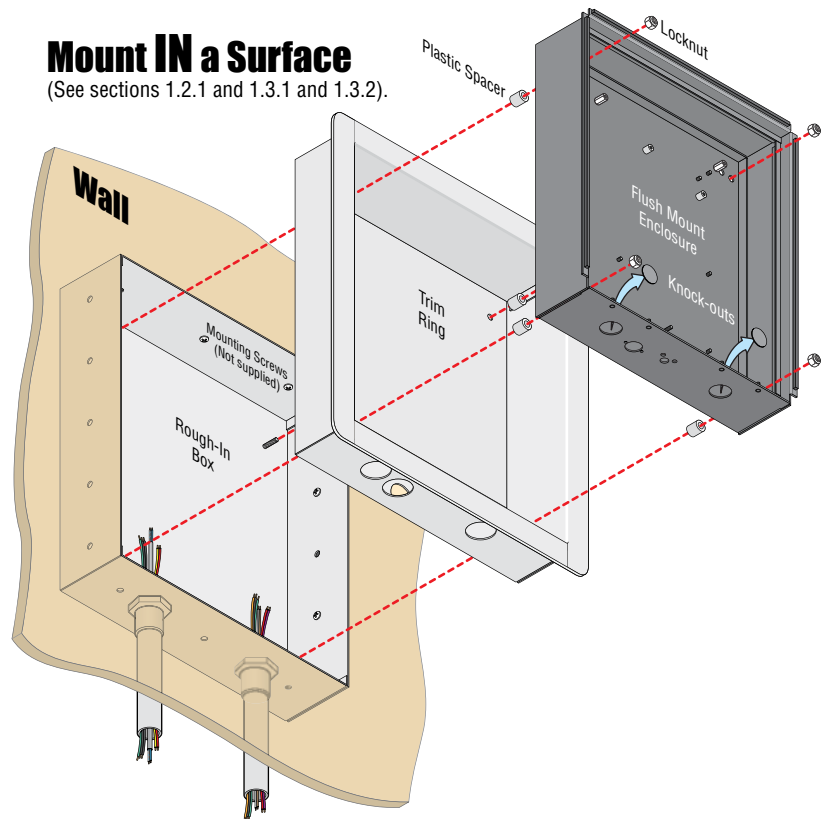

1.2 1803 & 1810 Surface Mount Dimensions

Surface mount units can be mounted directly to a wall, pilaster, post mounted using a DoorKing architectural style mounting post (P/N 1200-037 and 1200-038) or recessed in a wall (see next page) with the surface mount recess kit (P/N 1803-150). Be sure the unit is mounted securely and is not subject to vibration from closing doors or gates.

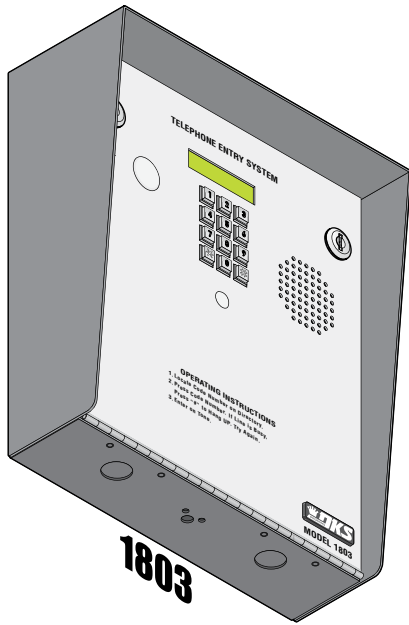

Back View

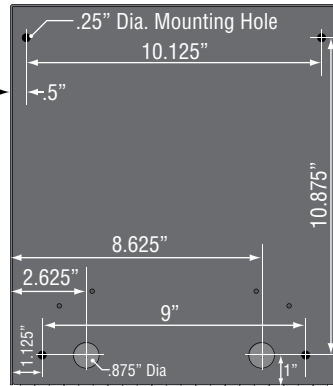

Side View

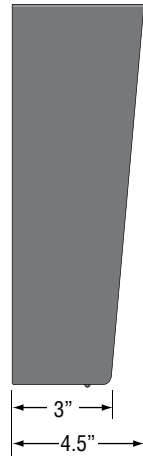

Front View

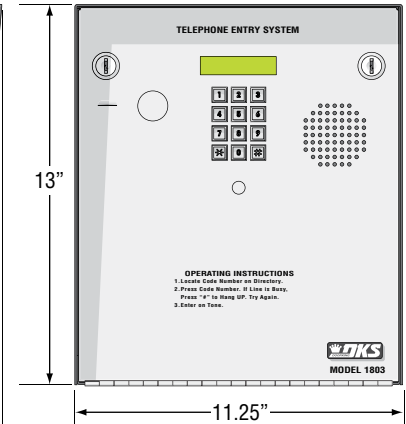

Bottom View

WARNING! If this entry system is used to control a vehicular gate with an automatic gate operator, the entry system must be mounted a minimum of six (6) feet away from the gate and gate operator, or in such a way that a person cannot operate the entry system and touch the gate or gate operator at the same time.



Back View

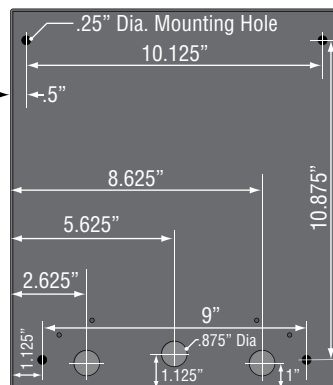

Side View

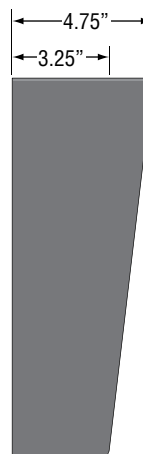

Front View

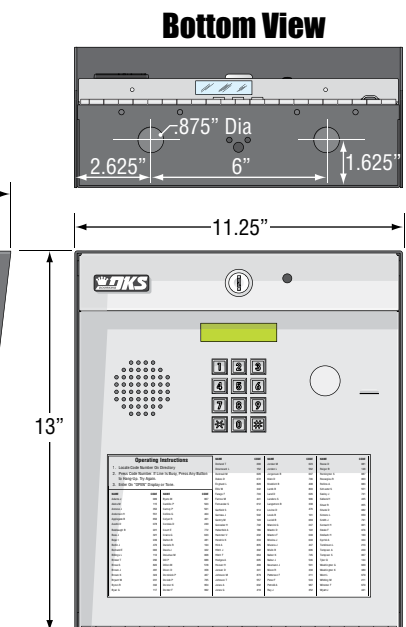

Bottom View



1.2.1 Surface Mount Recess Kit Installation for 1803 & 1810

1803 & 1810 surface mount units can be recessed into a wall or pilaster by using the optional surface mount recess kit if desired (P/N 1803-150). This allows a recessed 1810 telephone entry system to have a lighted keypad which the flush mount unit **DOES NOT** have. The recess box gets installed in the wall. Use appropriate hardware (not included) to secure the box in the wall. Run all necessary conduit (not included) to the recess box. Slide the enclosure in the recess box and secure it with the hardware included in the kit. Be sure the unit is mounted securely and is not subject to vibration from closing doors or gates.

WARNING! If this entry system is used to control a vehicular gate with an automatic gate operator, the entry system must be mounted a minimum of six (6) feet away from the gate and gate operator, or in such a way that a person cannot operate the entry system and touch the gate or gate operator at the same time.

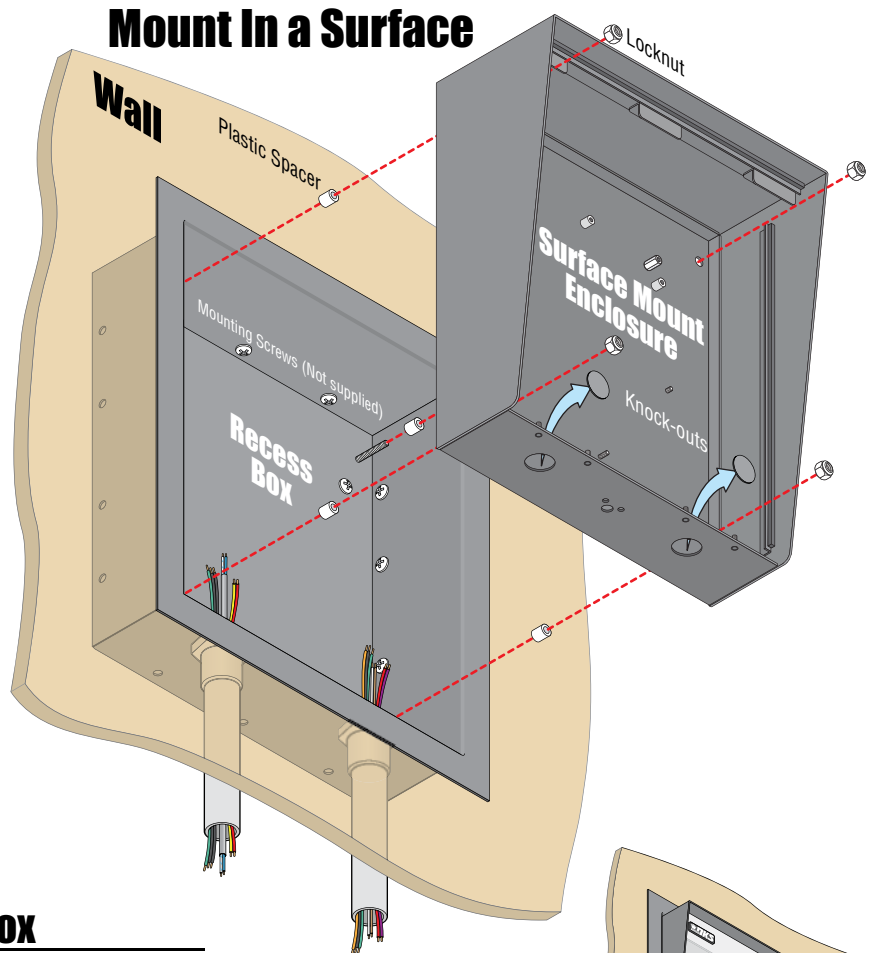

Recess Box

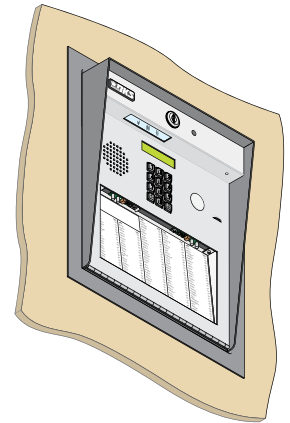
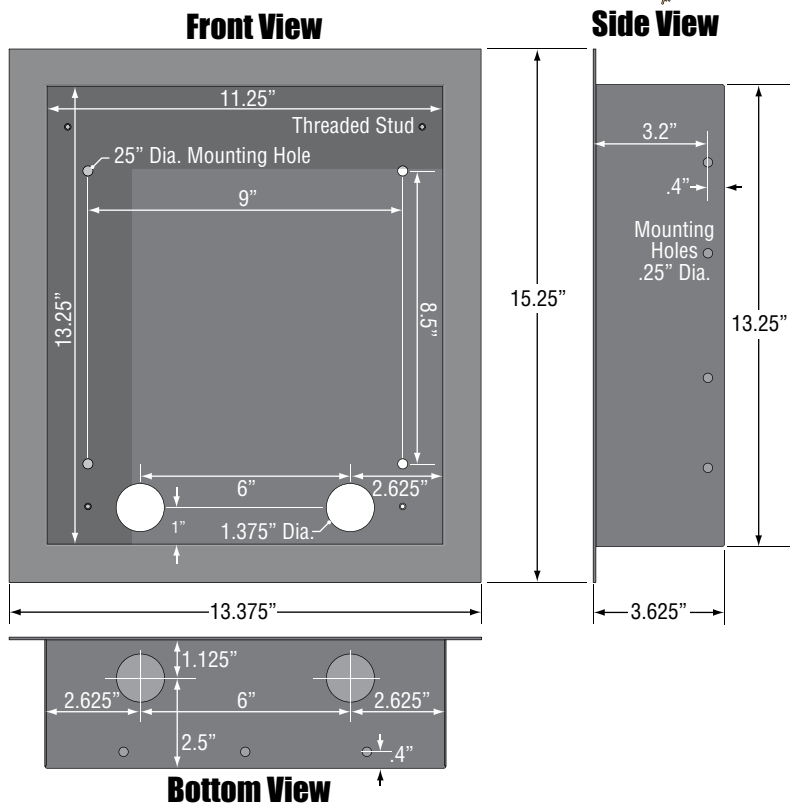

1.3 1803 & 1810 Flush Mount Dimensions

Flush mount 1803 & 1810 are installed with a flush mount kit P/N 1814-165 (stainless) or 1814-166 (gold). Flush mount kits are **NOT INCLUDED** with the flush mount entry system (See next page for flush mount kit installation).

DoorKing offers a self-standing lighted kiosk for the flush mount unit ideal for walk-up pedestrian applications P/N 1200-170 (See page 12 for self-standing kiosk installation).

The flush mount units may also be installed **ON** the surface of a wall with a flush mount surface mounting kit if desired P/N 1814-152 (silver only). Flush mount surface mounting kits are **NOT INCLUDED** with the flush mount entry system (See page 13 for flush mount surface mounting kit installation).

Flush mount 1803 & 1810 are installed into a wall/kiosk and can be mounted outside, exposed to the weather. It is preferred that they have limited direct exposure to the weather. We suggest that when they are mounted outdoors, it is in a covered protected area. Be sure the unit is mounted securely and is not subject to vibration from closing doors or gates.

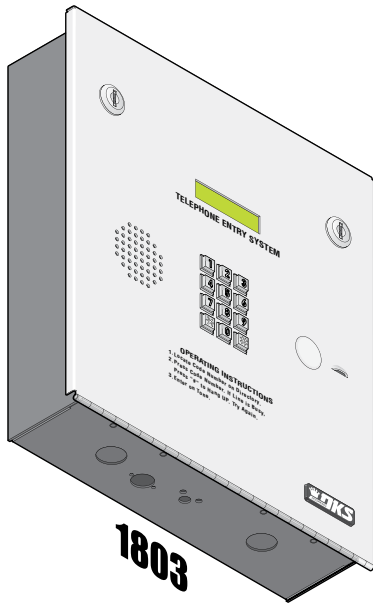

1803

WARNING! If this entry system is used to control a vehicular gate with an automatic gate operator, the entry system must be mounted a minimum of six (6) feet away from the gate and gate operator, or in such a way that a person cannot operate the entry system and touch the gate or gate operator at the same time.

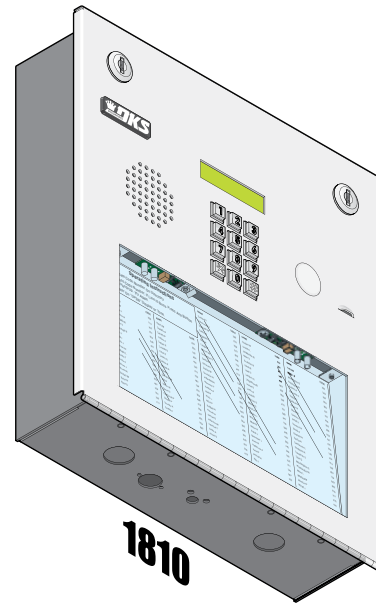

1810

Back View

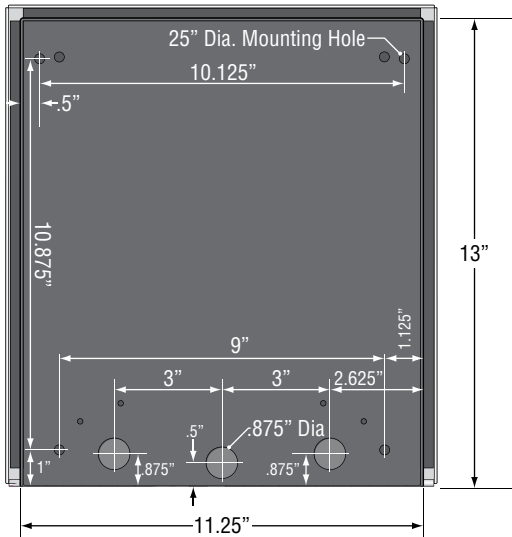

Side View



Front View

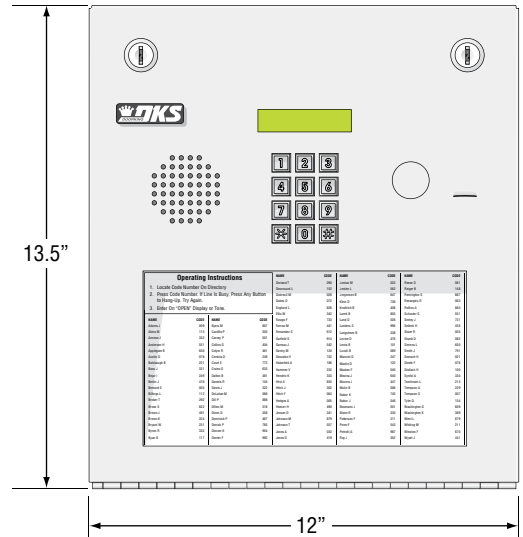

Bottom View

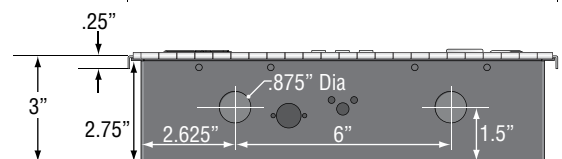

1.3.1 Flush Mount Kit Installation for 1803 & 1810

The flush mount kit has two parts; the rough-in box and the trim ring. The rough-in box is installed in the wall first. Use appropriate hardware (not included) to secure the box in the wall. Run all necessary conduit (not included) to rough-in box. Slide the trim ring into the rough-in box. Slide the enclosure in the trim ring and secure them all together with the hardware included in the kit. Be sure the unit is mounted securely and is not subject to vibration from closing doors or gates. See previous page for flush mount enclosure dimensions.

WARNING! If this entry system is used to control a vehicular gate with an automatic gate operator, the entry system must be mounted a minimum of six (6) feet away from the gate and gate operator, or in such a way that a person cannot operate the entry system and touch the gate or gate operator at the same time.

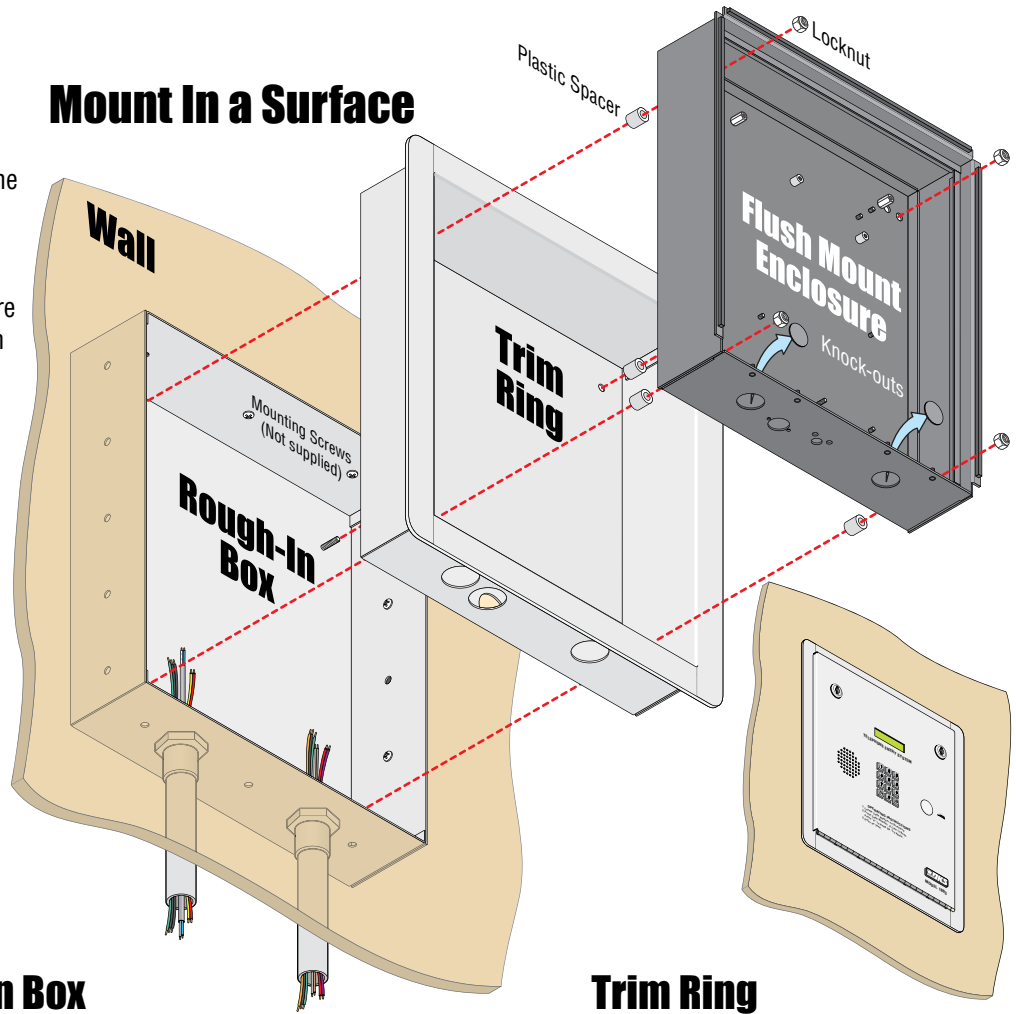

Rough-In Box

Trim Ring

Side View

Front View

Front View

Side View

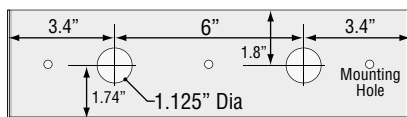
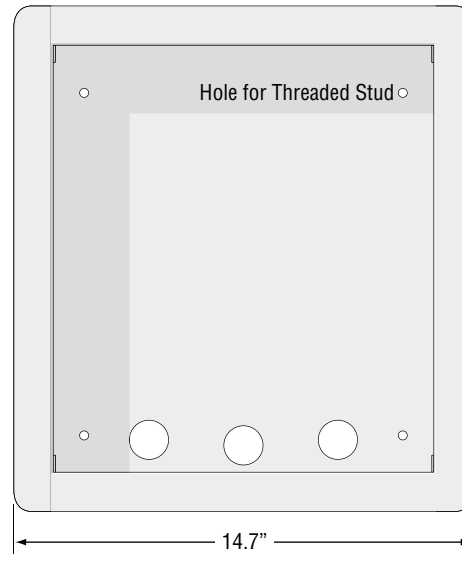
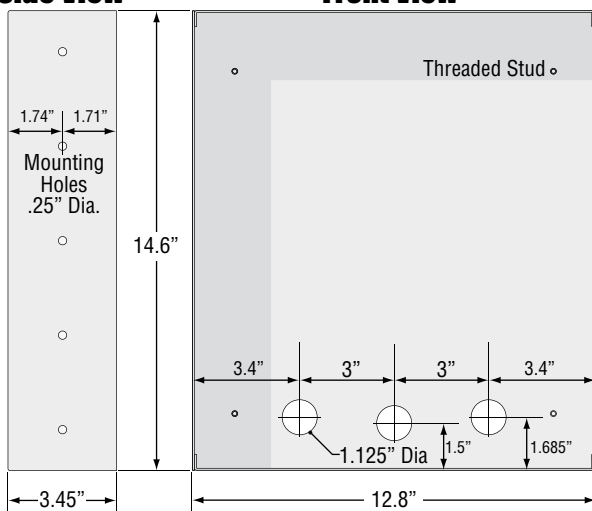

Bottom View

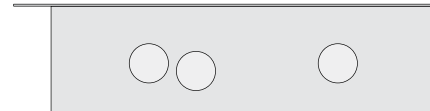

Bottom View

1.3.2 Self-Standing Lighted Kiosk Installation for 1803 & 1810

The flush mount kit (Sold separately) is installed into the self-standing kiosk (P/N 1200-170) to secure the flush mount 1803 or 1810 in place. Secure the rough-in box in the kiosk. Run all necessary wires to rough-in box. Slide the trim ring into the rough-in box. Slide the enclosure in the trim ring and secure them all together with hardware included in the kit.

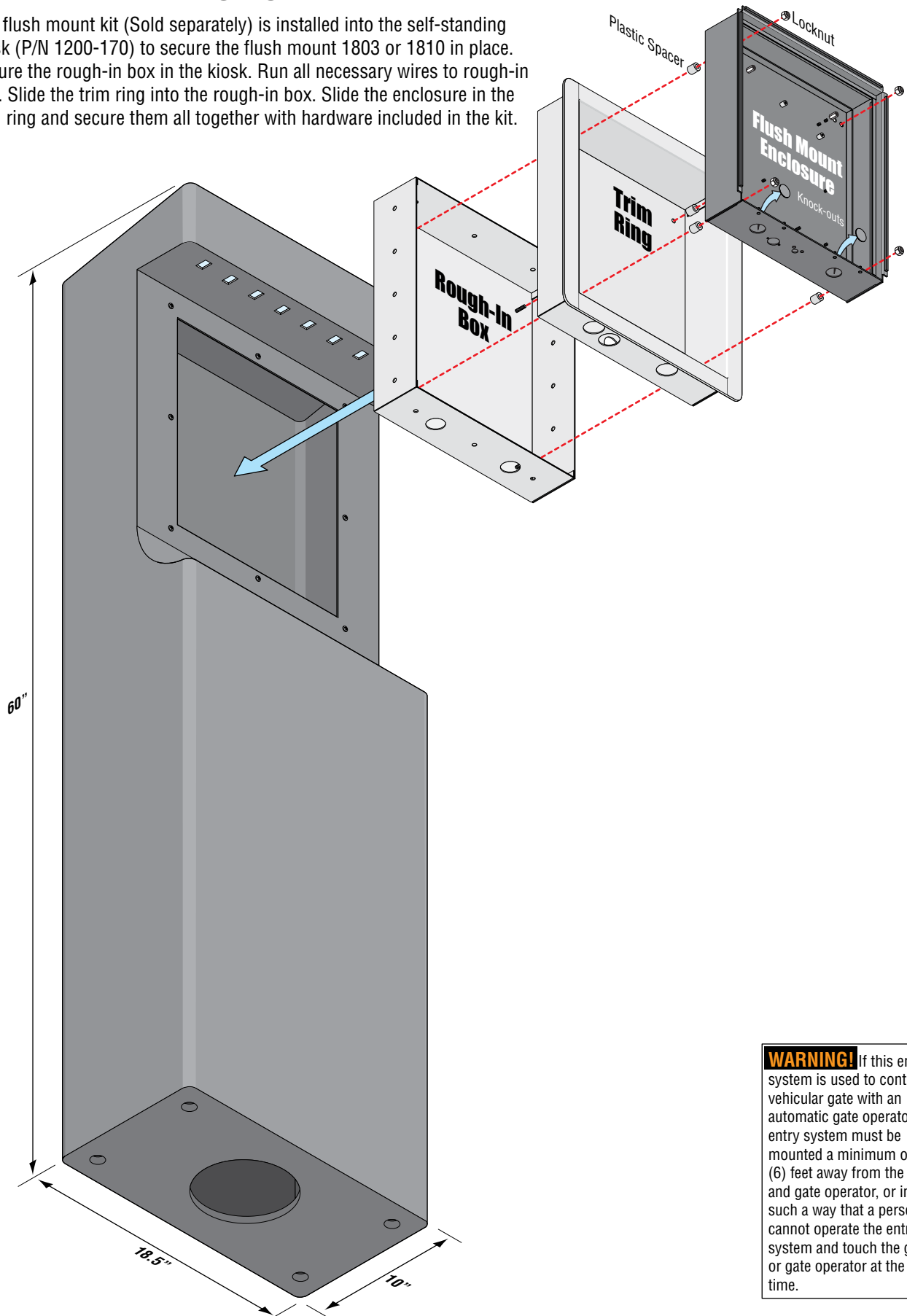

WARNING! If this entry system is used to control a vehicular gate with an automatic gate operator, the entry system must be mounted a minimum of six (6) feet away from the gate and gate operator, or in such a way that a person cannot operate the entry system and touch the gate or gate operator at the same time.

1.3.3 Flush Mount Surface Mounting Kit Installation for 1803 & 1810

Flush mount unit (See page 10 for flush mount enclosure dimensions) can be mounted **ON** a wall or pilaster and **NOT IN** the wall by using the optional flush mount surface mounting kit (P/N 1814-152). This is useful when cutting a large hole into a wall or pilaster would be very difficult (marble or granite for example). The flush mount surface mounting kit is a trim ring that fits around the flush mount enclosure. The enclosure and trim ring get installed directly on the wall using appropriate hardware (not included) after running all necessary conduit to the enclosure. Be sure the unit is mounted securely and is not subject to vibration from closing doors or gates.

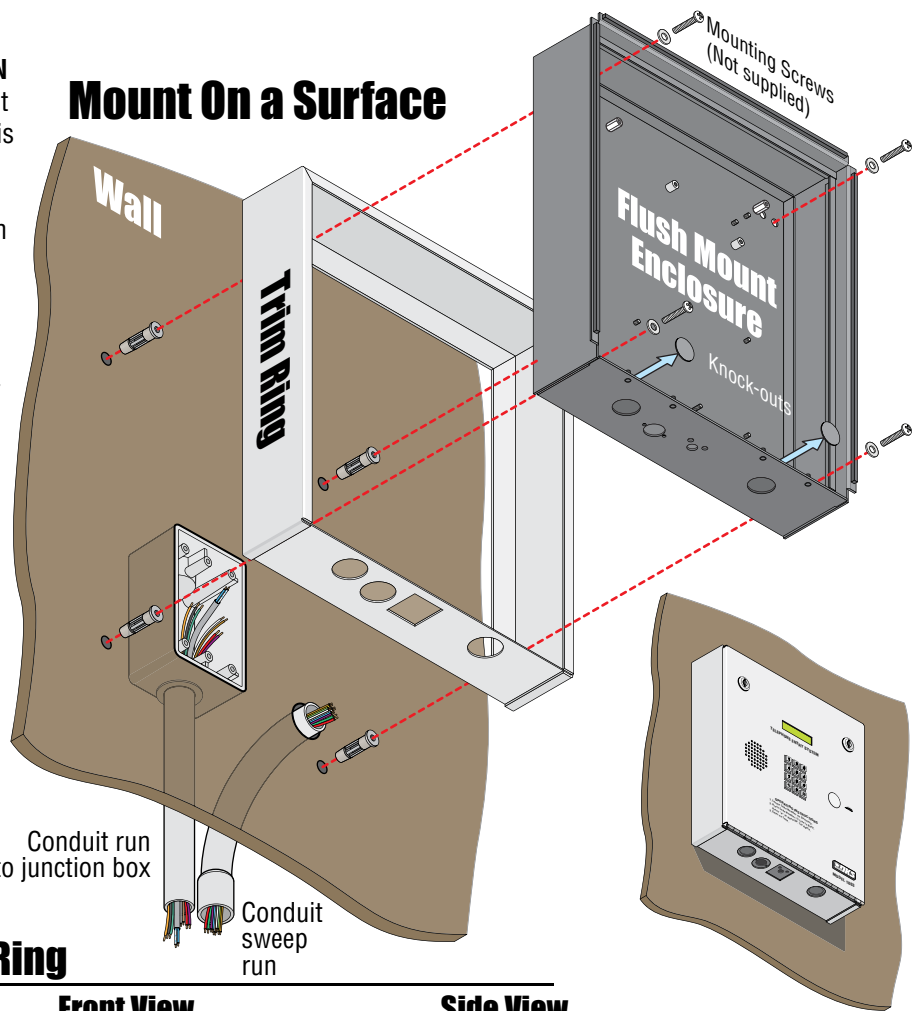

Examples of some small holes in the wall that may be needed, depending on how you choose to run the wiring.

Trim Ring

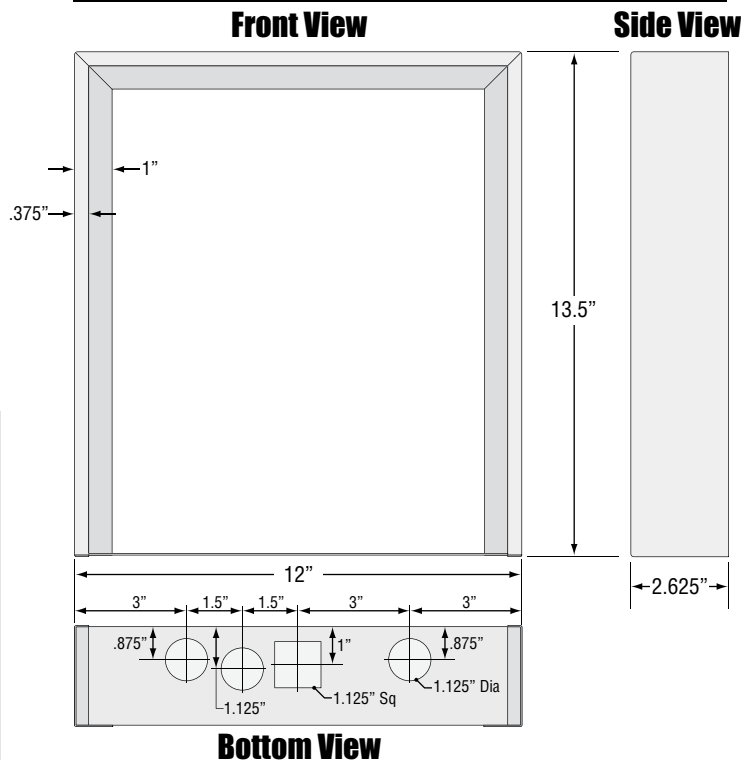

WARNING! If this entry system is used to control a vehicular gate with an automatic gate operator, the entry system must be mounted a minimum of six (6) feet away from the gate and gate operator, or in such a way that a person cannot operate the entry system and touch the gate or gate operator at the same time.

1.4 1808 Dimensions and Installation

1808 units can be mounted directly to a wall, pilaster, post mounted using a DoorKing mounting post (P/N 1200-045 or 1200-046). Be sure the unit is mounted securely and is not subject to vibration from closing doors or gates.

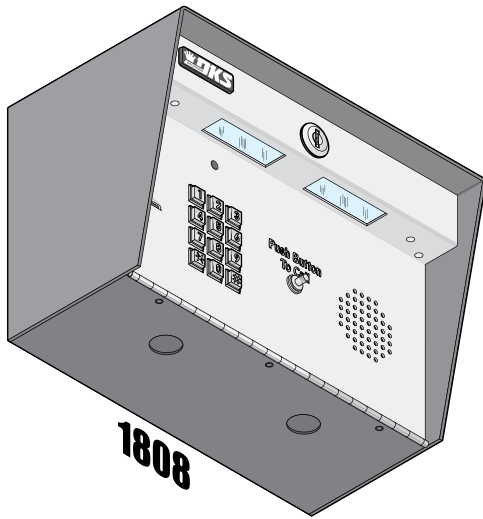

WARNING! If this entry system is used to control a vehicular gate with an automatic gate operator, the entry system must be mounted a minimum of six (6) feet away from the gate and gate operator, or in such a way that a person cannot operate the entry system and touch the gate or gate operator at the same time.



Back View

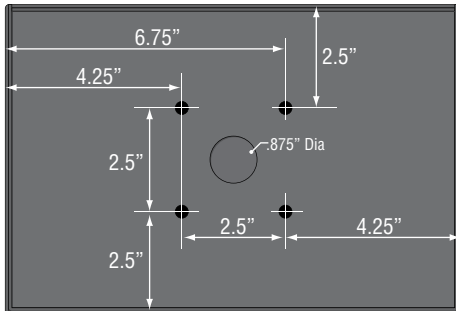

Side View

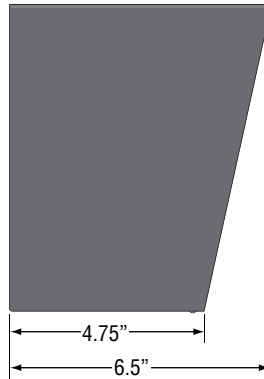

Front View

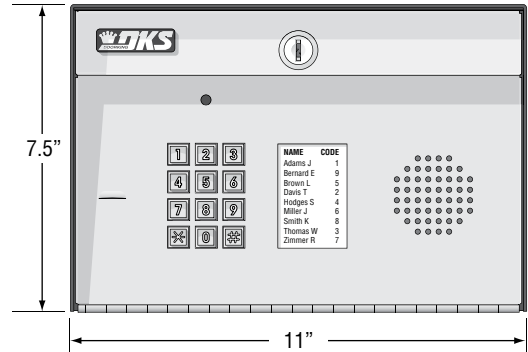

Bottom View

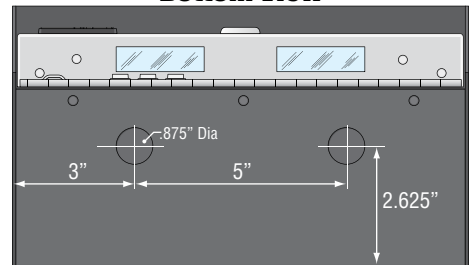

Mount to a Mounting Post

Use existing 4 holes in cabinet box to bolt the surface or wall mount models on a DoorKing mounting post. Use the hardware that is supplied with the mounting post.

Note: A gooseneck mounting post anchored in concrete does not make a good ground.

Mount Directly to a Wall or Pilaster

Use the 4 existing holes in the cabinet box. Run conduit inside or outside of wall or pilaster if desired. Use appropriate hardware to mount the cabinet (Not supplied). Be sure that the mounting hardware does not protrude into the cabinet where it could cause a short.

Plastic screw anchors for masonry if required. (Not supplied)

Conduit shown inside wall

Installation

1. Route all wiring through conduit or mounting post (not supplied).
2. Clean out the enclosure. Make sure that all dirt, metal and/or wood debris is removed.
4. Re-install components back into the enclosure (Reverse section 1.1.1). Use the wiring schematics in the back of this manual to help re-install the components if needed. **DO NOT** apply any power at this time.

1.5 Memory Chip Replacement

The Telephone Entry System is shipped with the memory chip already installed in the unit. However, if you need to replace the chip, follow the instructions below.

⚠ CAUTION

Power MUST be OFF to the Circuit Board!!

DO NOT install the memory chip with power to the telephone entry system turned ON. Attempting to install the memory chip with power on will irrevocably damage the chip. Memory chip is a static sensitive component. Discharge any static electricity from your hands by touching a proper ground device before touching the control board. Handle the memory chip with care, the pins bend easily.

DO NOT install the memory chip UPSIDE DOWN. this will cause permanent damage to the chip. Be sure that the memory chip is seated correctly in the socket.

Discharge any static electricity from your hands by touching a proper ground device before installing chip!

1862-010 Circuit Board Memory Chip Location

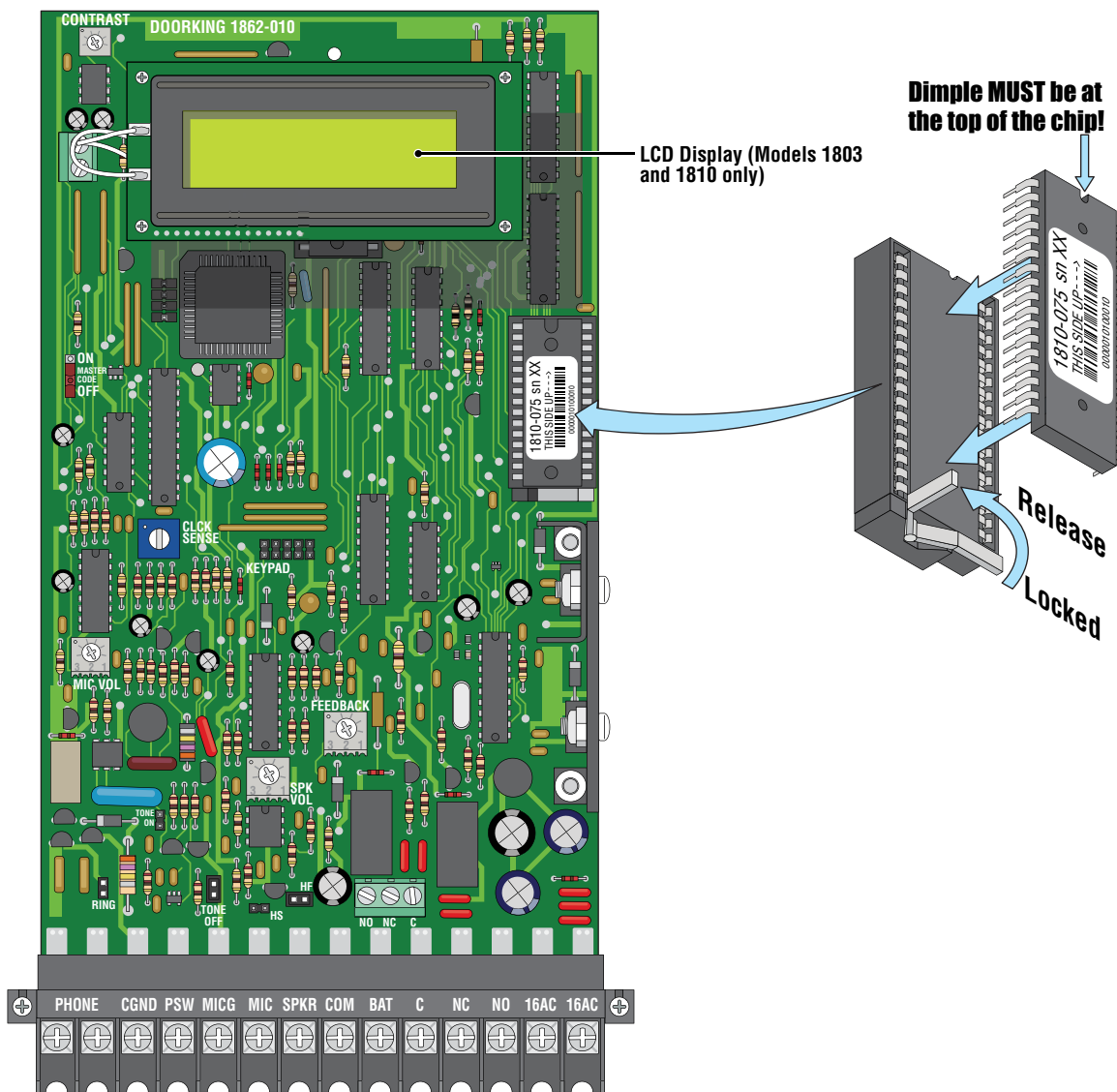

1.6 Postal Lock Installation

At some locations, such as gated communities, it will be necessary to **provide access to the mail carrier** so that they can deliver the mail. Mail carrier access will be provided by the installation of an **Arrow Postal Lock**. This is the same lock that the Post Office uses for gang mailboxes. **These locks are not available to the public.** The installer or the building owner/manager will have to call the Post Office and arrange for the installation of this lock into the telephone entry system. DoorKing 1803 & 1810 telephone entry systems are designed to accept installation of the postal lock. If you are using the 1808 and need postal service access, use the DoorKing Postal Lock Box sold separately (P/N 1402-080).

Prior to installation of the postal lock, be sure power to the telephone entry system is **turned OFF**.



1. Remove the hole plug on the faceplate of the telephone entry system.
2. Cut the wire tie wrapped around the switch **ONLY** when installing postal lock.
3. Remove the two hex nuts from the postal lock-mounting studs. Mount postal lock on the studs and secure with the hex nuts.

When the lock is installed, the pawl of the lock, in the **extended position** is **depressing the switch**. When the mail carrier inserts his key and turns the postal lock, the pawl is **withdrawn into the lock** and the switch will activate the relay for the programmed strike time, that has been programmed for this feature.

Factory default settings for the Postal Lock Switch: After the key has been turned, **Relay 1** will activate (section 3.1.7) for **One (1) second** of strike time (section 3.1.3).

Note: The switch input feature (section 3.1.7) is factory set to **“activate a relay”** and not **“dial a phone number”**.

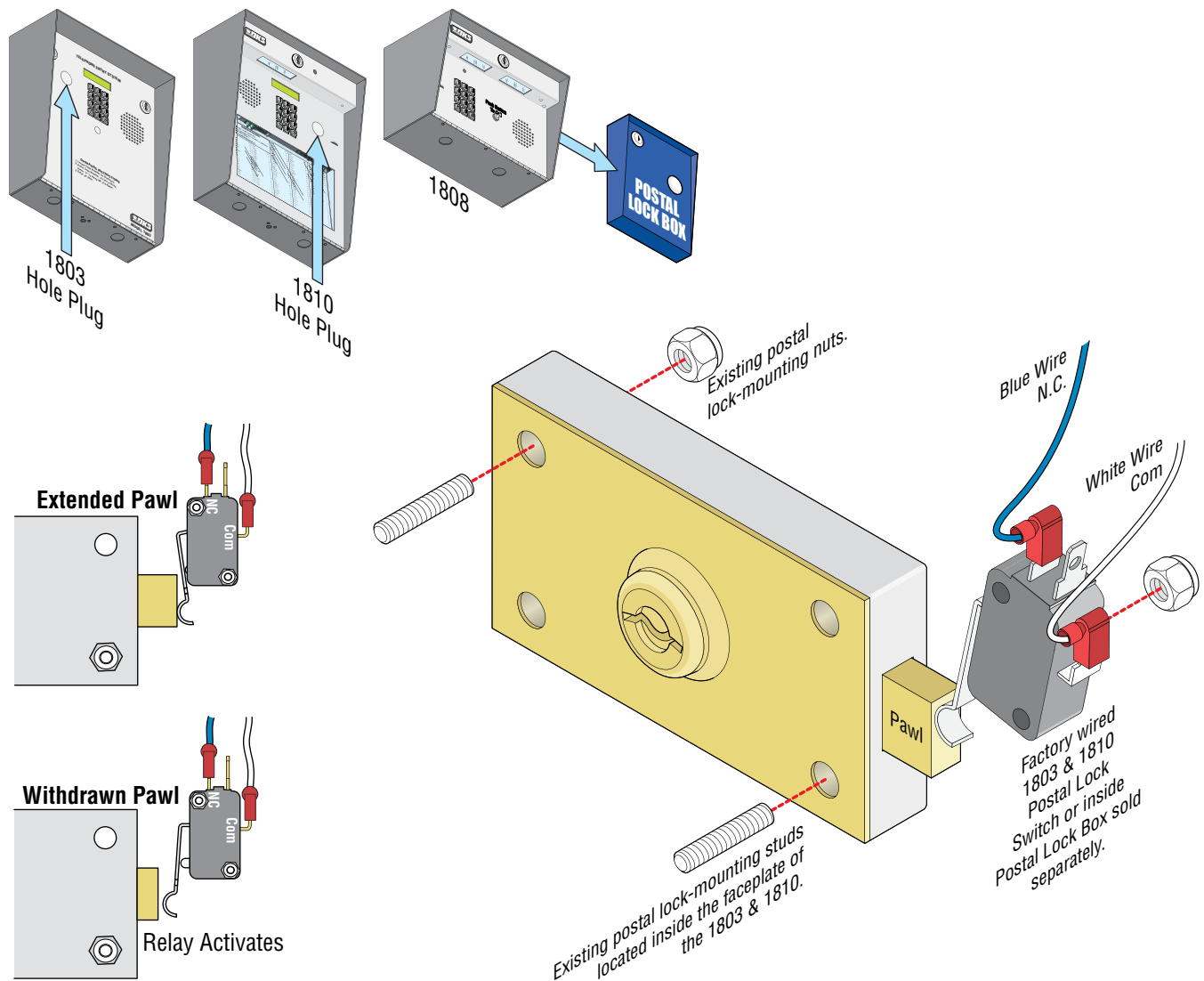

1.7 UL 294 Compliant Tamper Switch

The tamper switch needs to be connected to a security device or existing security system to comply with the UL 294 standard. Connect the 2 white wires of the **Normally Closed** gravity activated dry contact tamper switch to whatever security setup you desire. The gravity switch gets **activated** when the faceplate is **opened**. Repair and maintenance technicians may need to notify the proper authorities **BEFORE** opening the entry system faceplate, depending on how your security of this system has been setup.

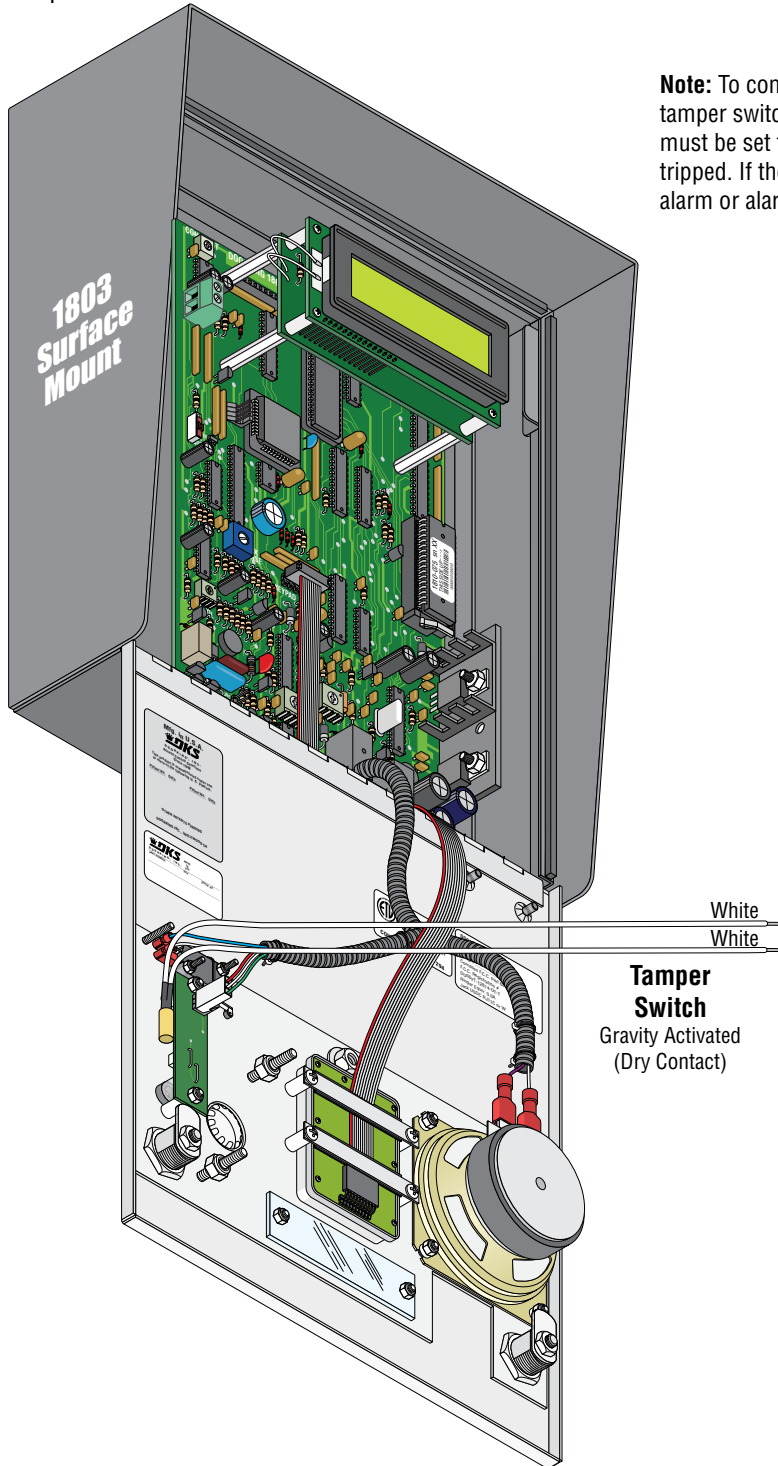

Note: To comply with UL 294 Standard for Safety, the tamper switch provided in this access control equipment must be set to activate an alarm or alarm signal when tripped. If the tamper switch is **NOT** connected to activate an alarm or alarm signal, **this will void UL 294 certification.**

Possible Security Connections

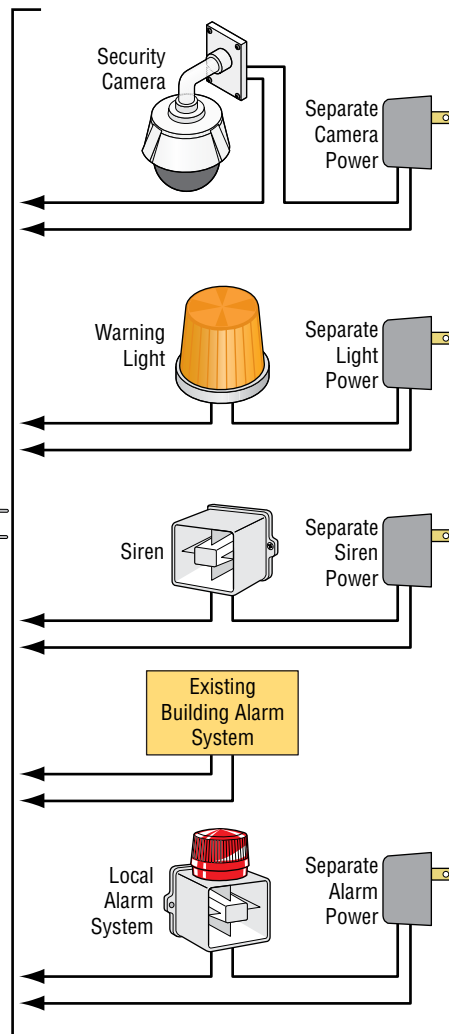

SECTION 2 - WIRING

Prior to installing wiring to the telephone entry system, we suggest that you become familiar with the instructions, illustrations, and wiring guidelines in this manual. This will help insure that your installation is performed in an efficient and professional manner.

The wiring of the telephone entry panel is an extremely important and integral part of the overall access control system. Use proper wire for the communication line, power wires, and be sure that the system is properly grounded. Check all local building ordinances and building codes prior to installing this system. Be sure your installation is in compliance with local codes.

Telcom Access Standards. It is not permissible for customers to use the telcom network lead-in cable to provide the intercom function between the gate and the house. New Zealand Customers: All door and gate entry systems wiring must comply with PTC106: March 2008, Section 9.

WARNING If this telephone entry system is used to control a vehicular gate with an automatic gate operator, the telephone entry system must be mounted a minimum of six (6) feet away from the gate and gate operator, or in such a way that the user cannot come into contact with the gate or gate operator when using this entry system. If this unit has been installed closer to the automated vehicular gate, do not proceed with any wiring until the unit has been moved and re-installed so that it is in compliance with these instructions.

This telephone entry system contains a number of static sensitive components that can be damaged or destroyed by static discharges during installation or use. **Discharge any static prior to removing the circuit board from the enclosure by touching a proper ground device.**

2.1 Wiring Guidelines

PERMANENT WIRING MUST BE EMPLOYED AS REQUIRED BY LOCAL ELECTRICAL CODES. ALWAYS ADHERE TO THE LOCAL AND NATIONAL ELECTRICAL CODE SPECIFICATIONS WHEN WIRING THE TELEPHONE ENTRY SYSTEM/ACCESS CONTROLLER AND OTHER ACCESS CONTROL DEVICES.

2.1.1 Power

Use only the supplied transformer (or UL listed equivalent) to power the telephone entry system. **DO NOT power any other devices (electric strikes, magnetic locks, lights etc.) from this power transformer.**

Note: Transformer is not supplied on units sold outside the United States. An Inherently Protected Transformer must be used to power this device. Only use transformer that is listed by a recognized testing laboratory to power the telephone entry system.

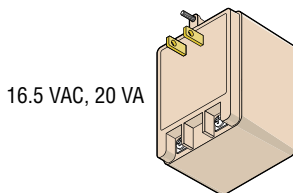

Do Not Connect To A Receptacle Controlled By A Switch.

Wire polarity does not matter

Up to 100 feet, use 18 AWG, 600 volt insulated wire.
Up to 200 feet, use 16 AWG, 600 volt insulated wire.

The importance of proper AWG power wiring cannot be over stressed!

Power wires are susceptible to noise and hum pickup; therefore it is preferable that you keep power wire runs as short as possible.

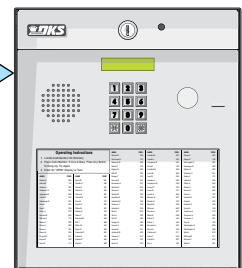

“Optional” 12 volt .8 amp hour gel-cell battery (DoorKing P/N 1801-008) can be installed to **provide stand-by power in the event of a power outage.**

2.1.2 Wire Runs

Be sure that you use proper wire that has an insulation rated for an underground environment. **All wires should be placed in conduits.** Proper pre-planning can greatly ease the installation and wiring of this system. Always check with the local building code to determine the type of wire required in your municipality.

DO NOT run high voltage (115 V) power lines and low voltage/communication lines in the same conduit. These should be in separate conduits at least six (6) inches apart. Be sure that all phone line wiring is twisted and completely isolated from ground.

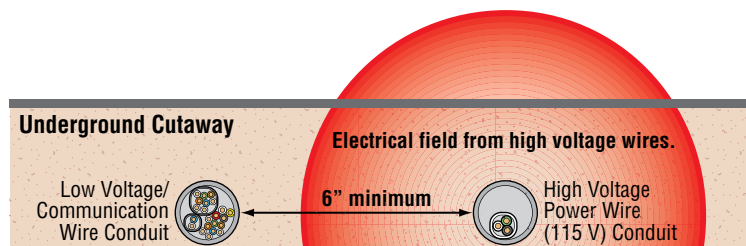

2.1.3 Grounding

Proper grounding of this system is a requirement. To be effective, ground connections should be made with a minimum 12 AWG, 600 volt insulated wire to a ground point within 10 feet of the telephone entry system. The ground point must be at an electrical panel, a metallic cold water pipe that runs in the earth, or a stainless steel grounding rod driven at least ten (10) feet into the soil. **A mounting post anchored to concrete does NOT make a good ground.**

Some Acceptable Ground Sources

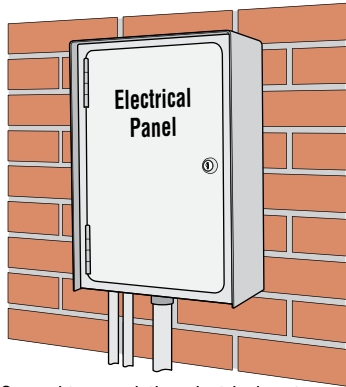

Ground to an existing electrical system.

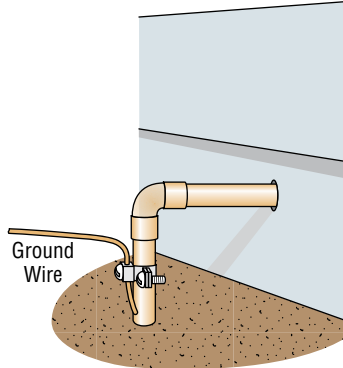

Ground to a metallic cold water pipe.

IMPORTANT: Ground wire shown without safety protection for clarity. Make sure ground wire is protected from being touched or electrical shock could occur!

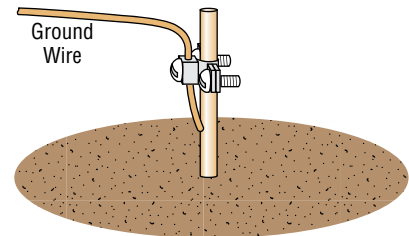

Grounding rod 10 feet in soil.

2.1.4 Surge Suppression

The use of surge suppressors can significantly reduce the chance of component failure because of static charges or surges. DoorKing recommends installing a **Phone Line** surge suppressor (DoorKing P/N 1877-010 or equivalent) and a **Low Voltage** surge suppressor (DoorKing P/N 1878-010 or equivalent) to help protect the entry system from power surges.

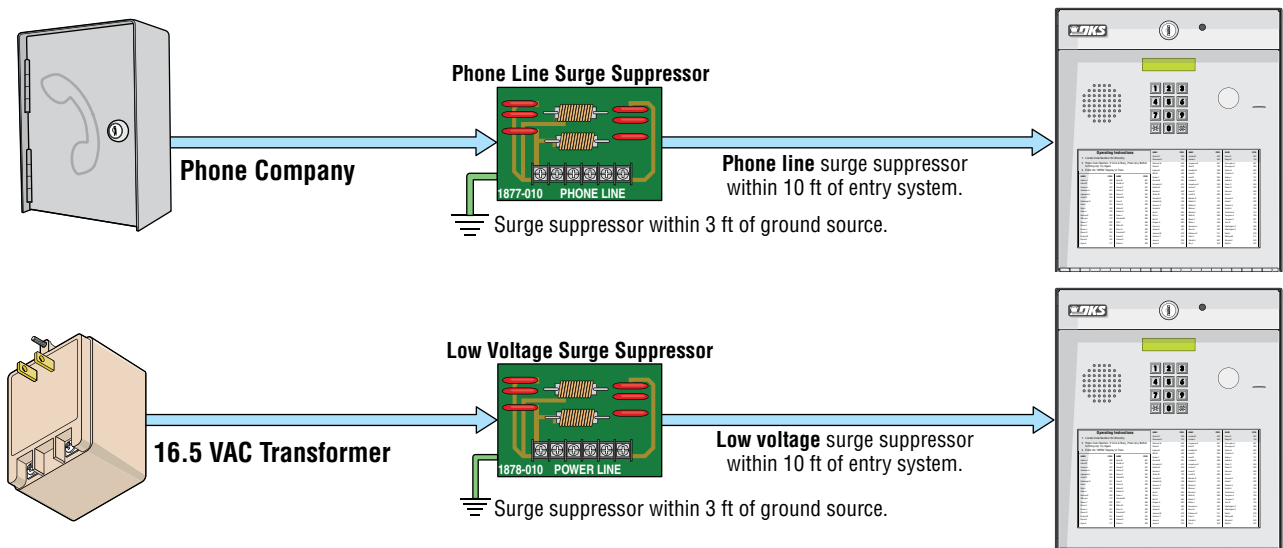

2.1.5 Ferrite Filter

The Telephone Entry System comes with a **Ferrite Filter**. This will help prevent noise and hum pickup in the phone lines. Install around the **16 VAC** power wires on the main terminal #13 and #14.

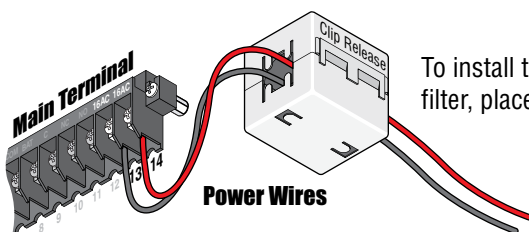

To install the ferrite filter, release the clip on the side to open the filter, place the wires in the circular core and snap the filter closed.

2.2 Terminal Descriptions

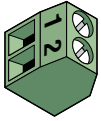

Located in the upper left corner of circuit board.

Switch Input 2 Terminal

Non-Removable

A closure between these terminals will cause **Relay 2** to activate for the programmed strike time or dial a preprogrammed phone number (see section 3.1.7).

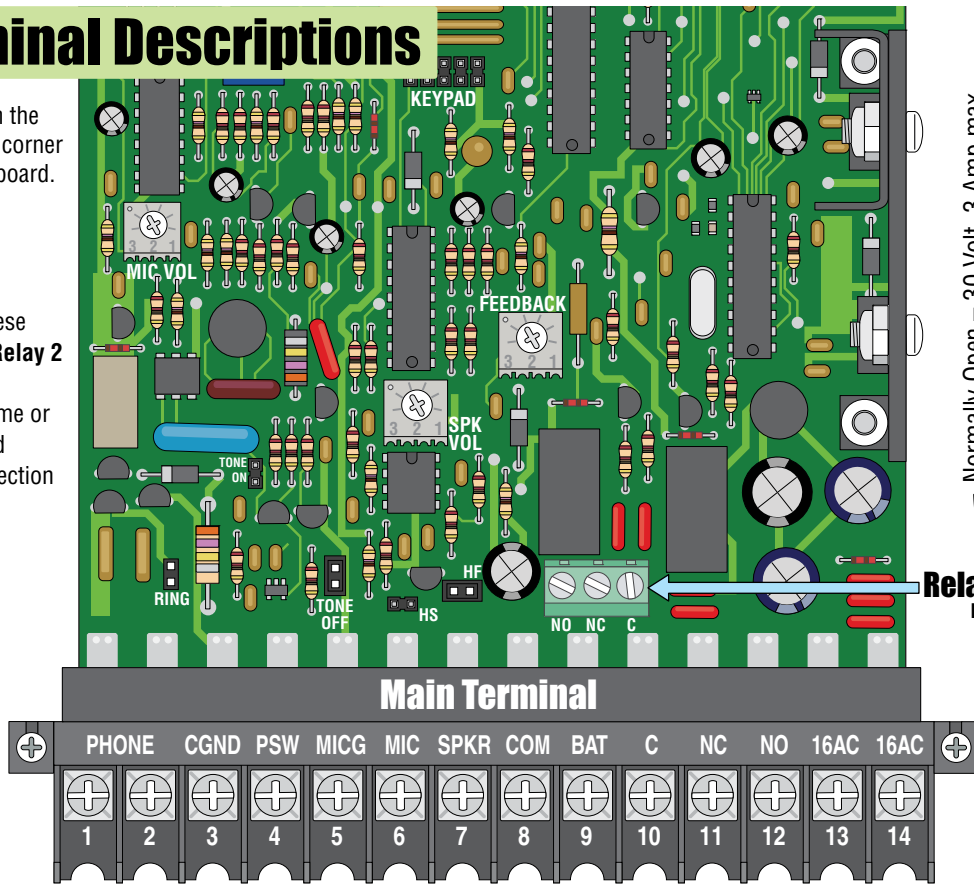

1 Phone Line Connection
2 Phone Line Connection Tip
3 Phone Line Connection Ring
4 Earth Ground Only (See Section 2.1.3). **NOT** a low voltage common.
5 Microphone ground Input (White Wire).
6 Microphone Input (Green Wire).
7 Speaker Output (Purple Wire).
8 Common for Switch Input 1 terminal #4, speaker, Standby Battery NEGATIVE
9 Standby Battery POSITIVE (12 VDC, .7 Ah, SLA) (connect negative to terminal 8)
10 **Relay 1** Common
11 **Relay 1** Normally Closed – 30 Volt, 3 Amp max.
12 **Relay 1** Normally Open – 30 Volt, 3 Amp max.
13 16 VAC Input Power
14 16 VAC Input Power

16 VAC Input Power 100 ft. max. with 18 AWG wire.
20 VA Minimum 200 ft. max. with 16 AWG wire.
Install ferrite filter on these wires - see section 2.1.5.

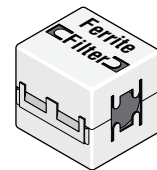

Do Not Connect Power To A Receptacle Controlled By A Switch.

Normally Open – 30 Volt, 3 Amp max.
Normally Closed – 30 Volt, 3 Amp max.
Common – 30 Volt, 3 Amp max.

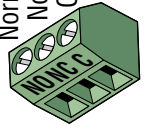

Relay 2 Terminal

Non-Removable

UL 294 Tamper Switch

Located under microphone board (See Section 1.7).

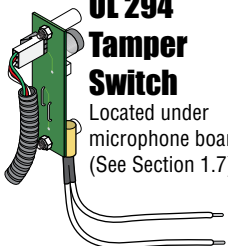

2.3 Telephone Entry System Wiring and Adjustments

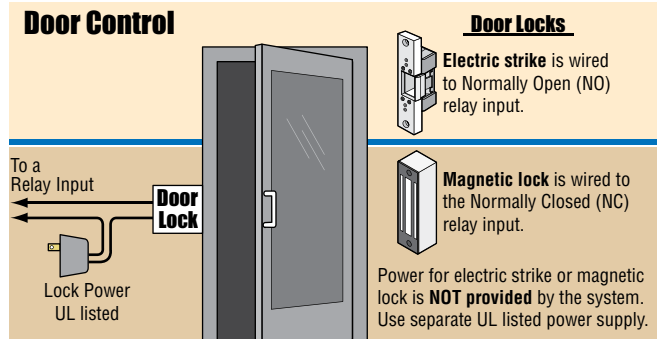
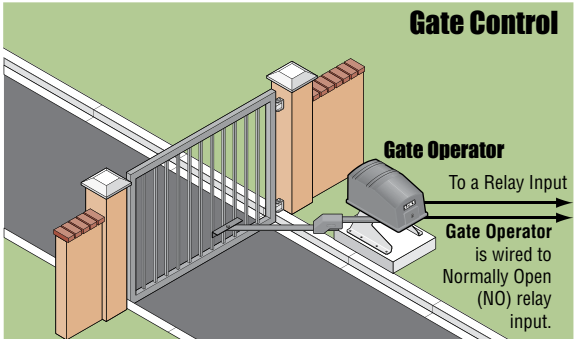
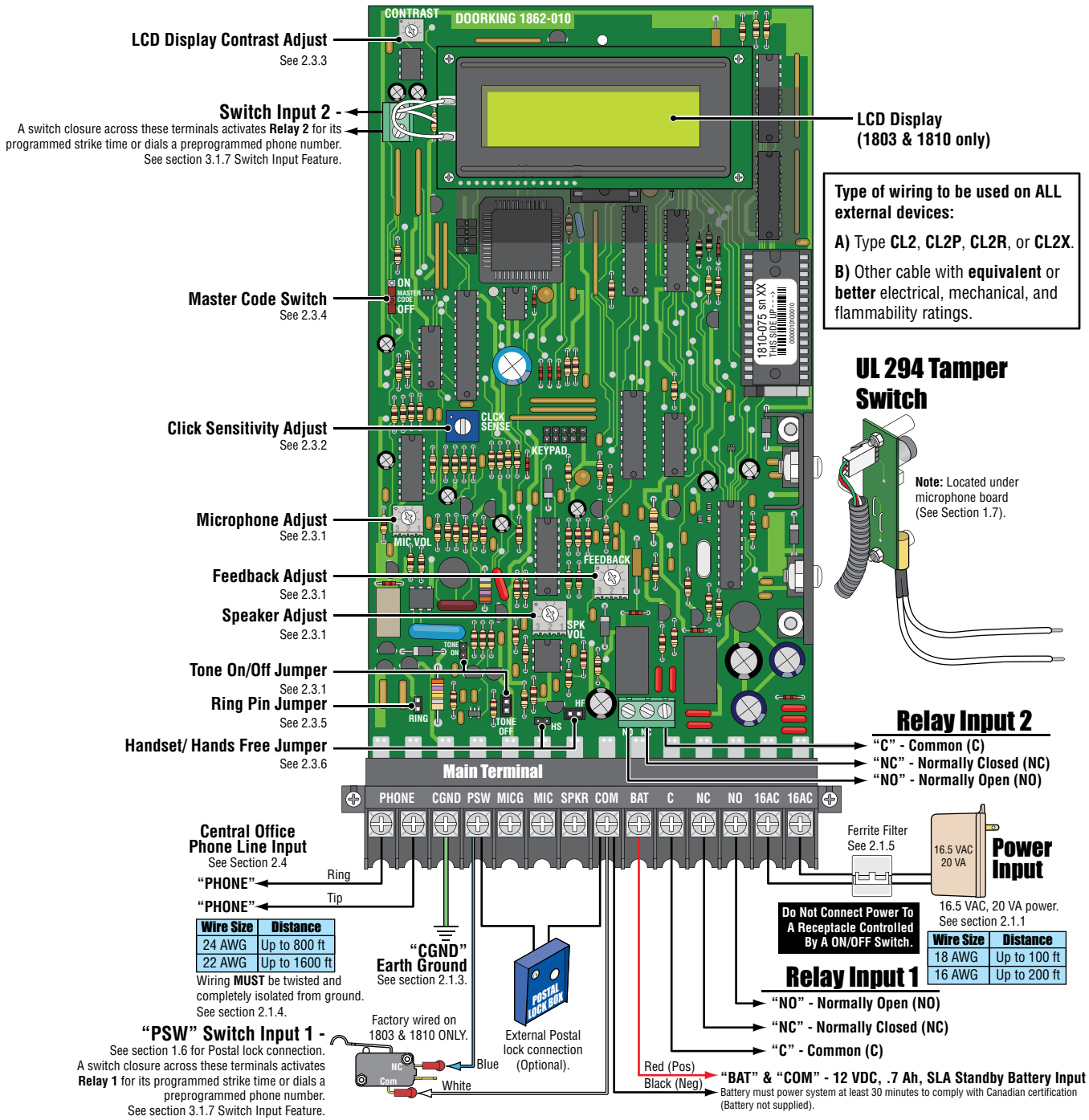

2.3.1 Speaker Volume, Microphone and Feedback

Speaker volume, microphone volume and feedback **ALL** interact with each other to affect the audio performance of the system.

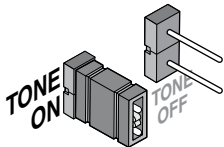

1. Locate the **speaker volume**, **microphone volume** and **feedback** adjustments on circuit board (see previous page).
2. Set the **speaker volume**: Place a phone call from the telephone entry system to a resident. While they are talking, adjust the speaker volume potentiometer for adequate sound. To increase the volume rotate the potentiometer clockwise, to decrease the volume rotate the potentiometer counter clockwise. See Feedback adjustment below.
3. Set the **microphone volume**: Place a phone call from the telephone entry system to a resident. Talk to the resident in a normal voice while adjusting the microphone volume potentiometer. Ask the resident to let you know when the sound in their telephone is adequate. To increase the volume rotate the potentiometer clockwise, to decrease the volume rotate the potentiometer counter clockwise. See Feedback adjustment below.
4. Set the **feedback**: Place a phone call from the telephone entry system to a resident. After they answer, ask the resident to remain silent.
5. While the resident is still on the line, remove the jumper from the **TONE OFF** terminals on the circuit board and place it on the **TONE ON** terminals. A tone will be heard in the speaker.
6. Rotate the feedback potentiometer clockwise, and then counter clockwise. When the tone from the speaker is minimum, this is the correct adjustment.
7. Jumper **MUST** be moved back to the **TONE OFF** terminals when complete.
8. High microphone and speaker volume levels may cause feedback. It may be necessary to reduce the speaker volume if the microphone volume is set too high. Likewise, it may be necessary to reduce the microphone volume if the speaker volume is set too high.

2.3.2 Click Sensitivity - Use for Rotary-Dial Phones ONLY



1. Locate the **click sensitivity** adjustment on circuit board (see previous page).
2. If rotary dial phones are **NOT** used, set the click sensitivity to **FULL counter-clockwise** to disable this feature. If rotary dial phones are in use, proceed to step 3.
3. Place a phone call from the telephone entry system to a resident with a rotary dial type phone. After they answer, ask the resident to dial 9 while you adjust the click sensitivity potentiometer (the resident may have to dial 9 several times for you to obtain the correct adjustment). When the door or gate opens, this is the correct adjustment for the click sensitivity.
4. Note: Adjusting the click sensitivity too high (potentiometer fully clockwise) could cause the system to respond to loud noises while it is in use. If this happens, rotate the click sensitivity potentiometer counter clockwise 1/8 turn and re-test the system. You may have to perform this step several times to find the correct adjustment.

2.3.3 LCD Display Contrast for 1803 & 1810

LCD display is adjusted at the factory and should **NOT** need to be re-adjusted. If it does, Let the system run for at least 10-minutes before making any display contrast adjustments.



1. Locate the **contrast** adjustment (see previous page).
2. Turn the **MASTER CODE** switch **ON**. The display will read **MST CODE**. While the display is lighted, turn the contrast potentiometer clockwise and then counter clockwise until the display is satisfactory.
3. **MASTER CODE** switch **MUST** be turned **OFF** when finished.
Note: Approximately 30 seconds after the master code switch is turned ON, the system will signal a long tone. This is normal and can be ignored. After the master code switch is turned OFF, the display will read MST CODE for approximately 30 seconds.

2.3.4 Master Code Switch

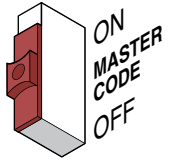

The master code switch **MUST** be kept in the **OFF** position for normal operation. Turn the master code switch **ON** when programming the system's master code. See section 3.1.1 to program the system's master code. If the master code switch is **turned ON** and a new master code is **NOT** entered, the system will sound a long tone after approximately 30 seconds. This tone will continue every 30 seconds until a new master code is entered, or until the switch is turned off. After the switch is turned off, the LCD display on 1803 & 1810 models will remain lit for approximately 30 seconds, and then will turn off.

Note: Master code switch is turned ON when adjusting the LCD display on 1803 & 1810 models, see section 2.3.3 for more information.

2.3.5 Ring Pin Jumper

Always Answer Calls

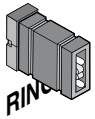

Never Answer Calls

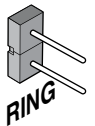

The ring pin jumper is labeled **RING** on the control board. This jumper **MUST** be installed to allow the system to **ALWAYS** answer the calls placed to it. If remote programming or remote relay operation is to be used, the jumper **MUST** be installed on the pins. Removing the jumper will cause the system to **NEVER** answer calls placed to it.

2.3.6 Hands Free – Hand Set Jumper

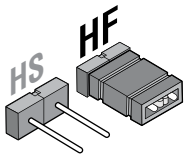

For **Hands Free (HF)** operation, the jumper is set in the right position from the factory. For a system with a **Hand Set (HS)**, the jumper is set in the left position from the factory. An optional handset kit (P/N 1807-012) is available for the 1803 and 1810 models **ONLY**.

DO NOT place jumpers on both the HS and HF pins at the same time.

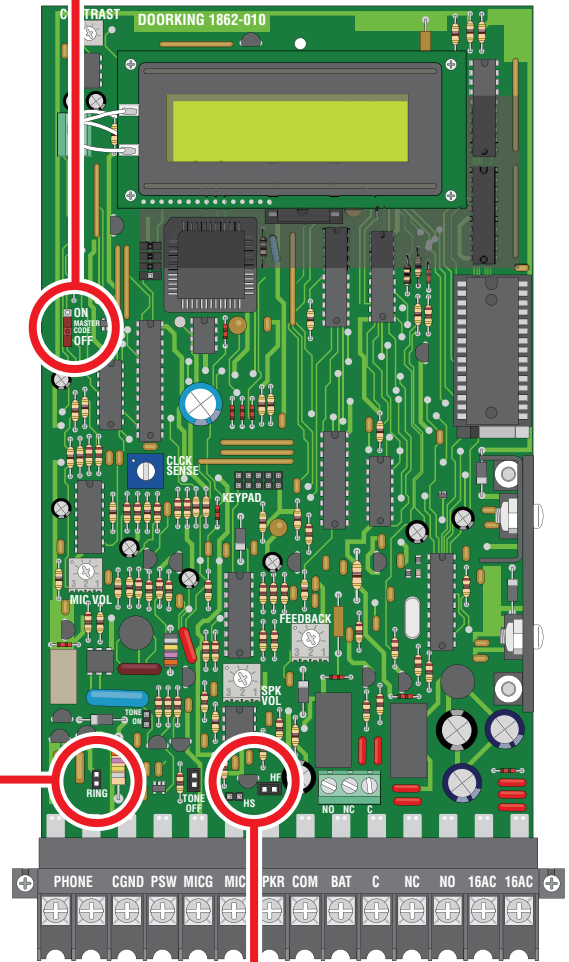

1803 with Hand Set

FLUSH Mount

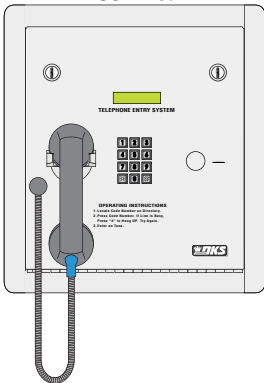

SURFACE Mount

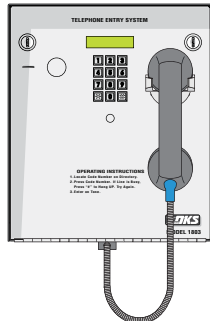

Optional handset jumper position.

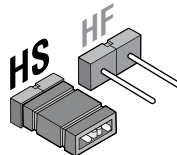

1810 with Hand Set

FLUSH Mount

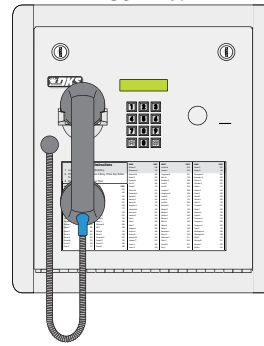

SURFACE Mount

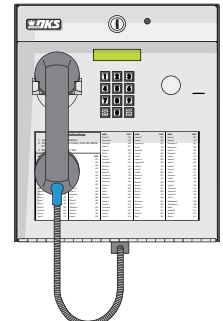

2.4 Phone (Voice) Connection Options

There are **THREE different ways** (Cellular, VoIP or Telephone Line) to connect the telephone entry system for voice communication. The method that you choose is dependent on the type of connection available at the entry system.

1 Wireless DoorKing Cellular Network Connection - Voice ONLY

Requires DKS VOICE ONLY Cellular System kit (P/N 1801-080). Manage 2 (two) entry systems through DoorKing's cellular network server where cellular service is available.

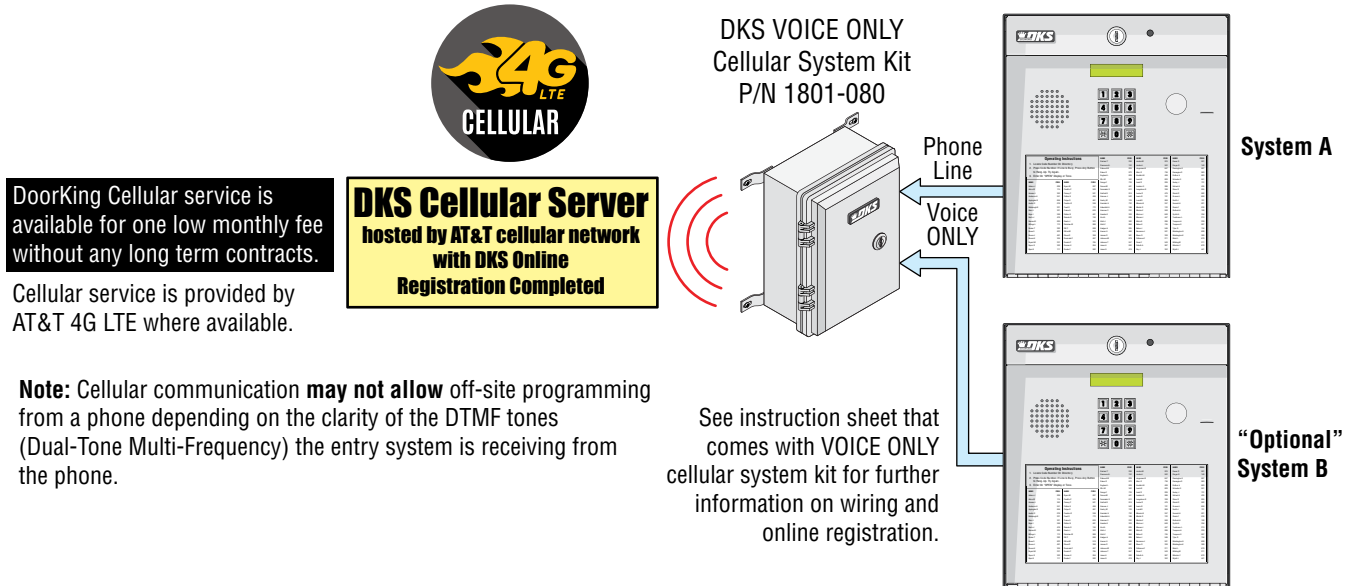

2 VoIP Internet Connection - Voice ONLY

There are **TWO** different ways to connect a VoIP box (Voice over Internet Protocol) to your existing internet connection:

Note: VoIP communication **may not allow** off-site programming from a phone depending on the clarity of the DTMF tones (Dual-Tone Multi-Frequency) the entry system is receiving from the phone.

A DoorKing VoIP Internet Connection

Requires a DKS VoIP Adapter Kit P/N 1815-568. Works through the internet.

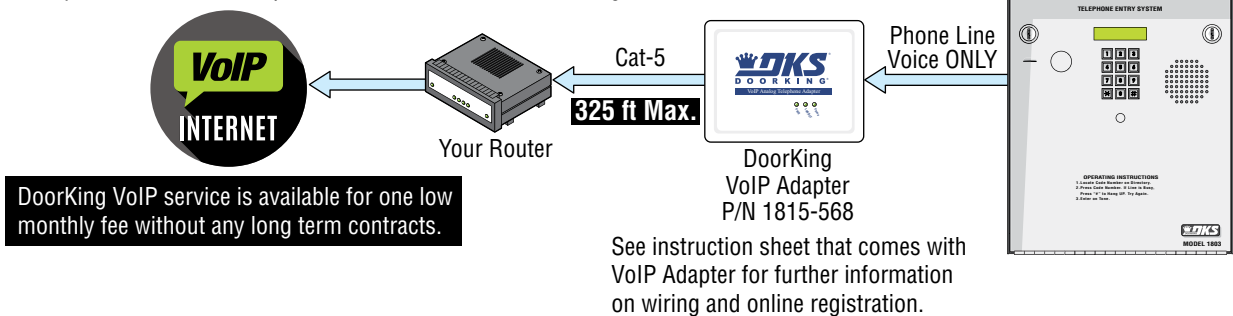

B Third Party VoIP Internet Connection

Requires a Third Party VoIP Adapter (most VoIP adapters will work). Works through the internet.

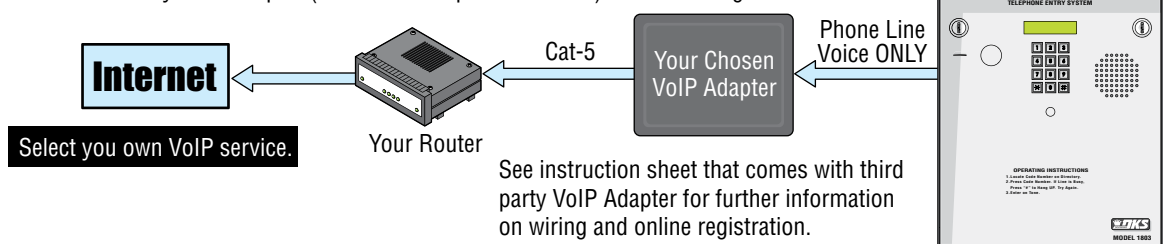

3 HARDwired Telephone Line Connection - Voice ONLY

Telephone Line Preparation

Order your telephone line to be installed at least two weeks prior to the planned telephone entry system installation date. This will assure that a phone line is available when the unit is installed. The telephone company will require the following information from you:

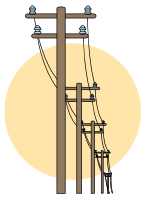

Type: Touch Tone, Loop Start
Ringer Equivalence: 0.0 A
Jack Type: RJ11C
FCC Registration (US): DUF6VT-12874-OT-T
DOC (Canada): 1736 4528 A

- Utilizes the POTS (Plain Old Telephone Service) copper line connected to the telephone entry system.
- Voice communication is provided over the POTS line. Programming the entry system using a phone can be preformed over this phone line if desired.
- User is responsible for all phone company charges including local and long distance charges, taxes and other fees for this line.

Note: Not applicable if Cable or Fiber is a cloud based telephone service.

Caller ID: You may want to order **caller ID blocking** from the telephone company for the entry system phone line. Without caller ID blocking, residents with the proper phone equipment **WILL BE ABLE** to identify the telephone number that the telephone entry system is installed on. This may or **MAY NOT** be desirable.

Call Waiting: Residents may order call waiting from their local telephone company **AFTER** the system has been installed. They can avoid missing calls coming from the telephone entry system while they are using their phone (No busy signal).

User supplied telephone line for Voice Connection.

You are responsible for the telephone line charges connected to the entry system.

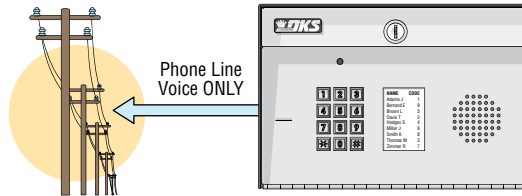

SECTION 3 - PROGRAMMING

We strongly suggest that you read these programming instructions in their entirety before beginning any programming of this telephone entry system.

DoorKing's 1803/1808/1810 Telephone Entry Systems can be programmed from the keypad (**Recommended**) on the front of the phone system, or remotely from an off premise location using a touch tone telephone. When programming from an off site location with a touch-tone telephone, the **RING** jumper **MUST** be installed on the circuit board (see 2.3.5). We recommend that you do not attempt programming from an off site location until you become familiar with these programming instructions.

IMPORTANT: Cellular or VoIP communication **may not allow** off-site programming from a phone depending on the clarity of the DTMF tones (Dual-Tone Multi-Frequency) the entry system is receiving from the phone.

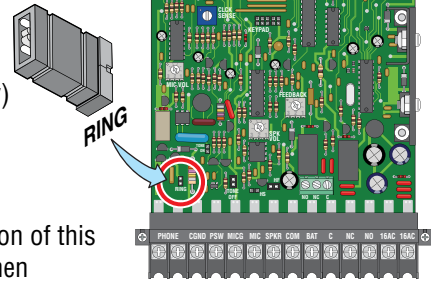

Programming from the Keypad

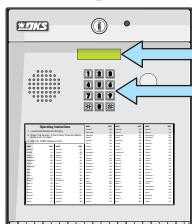

Follow the programming instructions as described in each section of this manual. The system will prompt you with short (beep) tones when programming steps have been followed correctly and with a long tone (beeeeeep) when the programming step is ended. The LCD display on 1803 & 1810 models will prompt you for information that you will need to enter.

Programming from an Offsite Location

Follow these steps when programming the system from an offsite location (remote). You **MUST** use a touch-tone telephone and the **RING** jumper **MUST** be installed to perform off site (remote) programming.

1. Call the telephone number that the entry system is installed on from a touch-tone telephone. The entry system will answer with a one second tone.
2. Follow the programming instructions as described in each section of this manual. The system will prompt you with short (**beep**) tones when programming steps have been followed correctly.
3. When complete, **hang up**. (You cannot use **0 #** to end remote programming sessions).



TIP: LCD screen on a phone will make programming **MUCH** easier.

Programming Notes

When each programming step is performed correctly, a short tone (**beep**) will be heard. When the programming session is ended, a long tone (**beeeeeep**) will be heard. The amount of telephone numbers that can be programmed into the standard system is 600. The memory size determines the number of four-digit entry codes (memory size + 12) that can be programmed into the system. Five-digit entry codes are limited to six.

3.1 General Programming

3.1.1 Master Code

This programming step sets the system **MASTER CODE**. The master code is the four-digit number required to gain access to the system memory. You need to know the master code prior to performing any of the programming functions on the following pages.

Factory setting = NO Factory code set

1. Open the cabinet of the telephone entry system and turn the master code switch **ON**.
2. Choose and enter a four-digit master code (**beep**).
3. Turn the master code switch **OFF** and close the cabinet.

Important Note: There is no way of retrieving the master code after it has been programmed in. If you forget it, you will have to program in a new one but all other previously programmed information will remain intact. Use log tables in back of manual to record your new master code. Keep it secure!

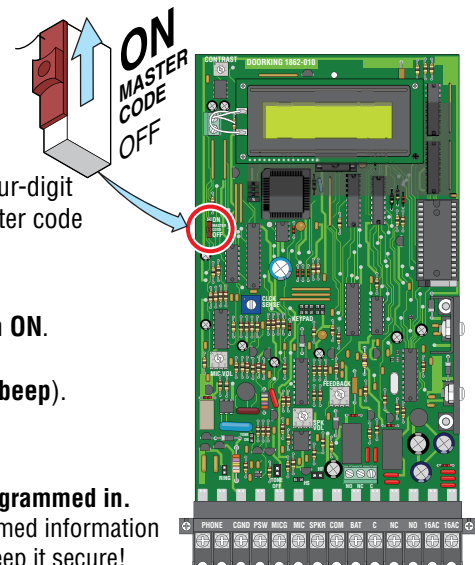

Overview for System Programming

	Page #	Section	Command	Factory Setting
Section 3.1 General Programming				
Master Code	26	3.1.1	Master Switch ON	NO Factory setting
Single or Multiple Systems	28	3.1.2	* 04	0 (single)
Relay Strike Time	28	3.1.3	* 03	Relay 1= 01 (1 sec) Relay 2= 01 (1 sec)
“Tone Open” Sound ON or OFF	28	3.1.4	* 17	1 (tone ON)
Talk Time	28	3.1.5	* 08	060 (60 sec)
Tone Open Numbers	29	3.1.6	* 05	Relay 1= 9 8 7 6 Relay 2= 5 4 3 2
Programming Switch Input 1 and Switch Input 2	29	3.1.7	* 23	0 (relays activate)
Number of Rings Before Telephone Entry System will Answer	29	3.1.8	* 18	02 (two rings)
PBX Line Access Code Programming	30	3.1.9	* 21	
Star Key (*) Function	30	3.1.10	* 27	0 (hang-up)
Keypad Function (DTMF Programming)	30	3.1.11	* 26	0 (all numbers)
System to Stay On-Line or Hang-Up after Touch-Tone Number Pressed	30	3.1.12	* 28	1-relays hang-up
Automatic Hang-Up Function	31	3.1.13	* 40	1 (hang-up after 5 sec of dial-tone)
Section 3.2 Directory Code and Phone Number Programming				
Programming the Directory Code Length	32	3.2.1	* 20	3 (3 digits)
# Key - Insert an Amount of “Pause Time” Between Phone Number Digits	32	3.2.2	* 42	0 (0 sec)
Programming Phone Numbers - Up to 16-Digits	33	3.2.3	* 01	
Deleting Individual Phone Number	33	3.2.4	* 01	
Deleting ALL Phone Numbers CAUTION	34	3.2.5	* 22	
Display / DELETE Phone Numbers with UNKNOWN Directory Codes	34	3.2.6	* 25	
Display Phone Numbers with KNOWN Directory Codes	34	3.2.7	* 06	
7-Digit Phone # - Limited Use - 7-Digit Phone Number Capability CAUTION	35	3.2.8	* 44	0 (No)
16-Digit Phone Number Capability CAUTION	35	3.2.9	* 45	1 (Yes)
Programming 7-Digit Phone Numbers	36	3.2.10	* 01	
Programming Area Codes (Area Code Reference Numbers)	36	3.2.11	* 24	
Programming Phone Numbers WITH Area Code Reference Numbers	37	3.2.12	* 41	
Deleting Individual 7-Digit Phone Number	37	3.2.13	* 01	
<div style="border: 1px solid black; padding: 2px; display: inline-block;"> These sections are NOT used for Factory Set 16-Digit Phone Number Programming </div>				
Section 3.3 Entry Code Programming				
Programming Four-Digit Entry Code	38	3.3.1	* 02	
Delete Individual Four-Digit Entry Code	38	3.3.2	* 14	
Delete ALL Four-Digit Entry Codes CAUTION	38	3.3.3	* 00	
Four-Digit Entry Code Divide Number to Activate Relays	38	3.3.4	* 12	9999
Four-Digit Entry Code (Reverse Relay Activation ONLY)	39	3.3.5	* 19	
Programming Five-Digit Entry Code	39	3.3.6	* 09	
Delete Individual Five-Digit Entry Code	39	3.3.7	* 10	
Delete ALL Five-Digit Entry Codes CAUTION	39	3.3.8	* 11	
Five-Digit Entry Code Divide Number to Activate Relays	39	3.3.9	* 13	9999
Section 3.4 Time Functions Programming				
Programming Time Clock	40	3.4.1	* 33	
Automatic Relay Activation Time Zones	40	3.4.2	* 35	
Four-Digit Entry Codes Time Zone	41	3.4.3	* 36	
Five-Digit Entry Codes Time Zone	42	3.4.4	* 37	
“Flash Entry Codes” Active for ONE-DAY ONLY	42	3.4.5	* 15	

Important Note: If you make a mistake while programming, press **0** **#** keys at the same time to escape from programming no matter how much has been completed, then begin again at step 1.

3.1.2 Single or Multiple Systems

This program sequence sets the telephone entry system to operate as a single unit on the phone line, or to share the phone line with other units. If multiple systems are sharing the same phone line, then each one must be set as a “multiple system” and each must have a unique master code.

Factory setting = 0 (Single System)

1. Press ***** **0** **4** and enter your four-digit MASTER CODE **?** **?** **?** **?** (beep).
2. Press **0** ***** (beep) for a **single system**, OR **1** ***** (beep) for **multiple systems**.
3. Press **0** **#** together to end this programming sequence (beeeeeep).

3.1.3 Relay Strike Time

These steps will program Relay 1 and Relay 2 strike times. Strike times can be programmed from 1/4 second (enter 00 in step 3) up to 99 seconds by entering the desired time in seconds.

Factory setting for relay strike times are: Relay 1 = 01 (1 sec), Relay 2 = 01 (1 sec).

1. Press ***** **0** **3** and enter your four-digit MASTER CODE **?** **?** **?** **?** (beep).
2. Press **1** ***** (beep) to set **Relay 1**, OR **2** ***** (beep) to set **Relay 2** strike time.
3. Enter the **two-digit strike time** in seconds (00-99), then press ***** (beep).
(Example: 1/4 second - enter 00, 1 second - enter 01 etc.)
4. Repeat steps 2 and 3 to set other relay strike time.
5. Press **0** **#** together to end this programming sequence (beeeeeep).

3.1.4 “Tone Open” Sound ON or OFF

The following programming sequence turns the “Tone Open” sound either On or Off (when the relays activate). This feature is available on Rev L boards or higher. See 3.1.6 for information about “Tone Open” numbers feature.

Factory setting = 1 (tone ON)

1. Press ***** **1** **7** and enter your four-digit MASTER CODE **?** **?** **?** **?** (beep).
The 1803 & 1810 LCD display will read: **1=Y 0=N**
2. Enter **1** for **YES - tone will sound** or **0** for **NO - tone will not sound**, then press ***** (beep).
3. Press **0** **#** together to end this programming sequence (beeeeeep).

3.1.5 Talk Time

This programming sequence sets the maximum time allowed for conversation when the entry system places a call to the resident. The talk time can be set from 1 second up to 255 seconds (4 minutes, 15 seconds) and is entered as a three-digit number in step 3. The talk time set here **DOES NOT** affect the telephone numbers that are programmed under **directory codes 0, 00, 000, 0000 and 1, 01, 001, 0001**. The talk time for these two directory code sets are **factory set to the maximum**. Phone numbers programmed under these directory codes should be reserved for management or emergency phone numbers that generally require longer conversations.

Factory setting for talk time = 060 (60 seconds).

1. Press ***** **0** **8** and enter your four-digit MASTER CODE **?** **?** **?** **?** (beep).
2. Enter the **three-digit talk time** in seconds (001-255), then press ***** (beep).
(Example: 1 second - enter 001, 20 seconds - enter 020 etc.)
3. Press **0** **#** together to end this programming sequence (beeeeeep).

3.1.6 Tone Open Numbers

These steps will program the tone open numbers for Relays 1 and 2. You will need to enter a four-digit number (see chart below) to set the relay functions. **If a function is not desired, enter # in place of a number.**

Fill out log table in back of this manual for desired tone open numbers.

Factory setting is: Relay 1 = 9876, Relay 2 = 5432.

1. Press *** 0 5** and enter your four-digit MASTER CODE **?? ??** (beep).
2. Press **1 *** (beep) to set **Relay 1**, OR **2 *** (beep) to set **Relay 2**.
3. Enter the **four-digit tone open number code**, then press ***** (beep).

(Example: If you want a relay to have a momentary activation function **ONLY**, and you want that relay to momentary activate when the number 9 is pressed, enter **9 # # #**. If a function is not desired, enter # in place of a number. **DO NOT** duplicate 4-digit tone open numbers, Example: **DO NOT** set any of Relay 1's 4-digit tone open numbers to the same number - **9879**.)

4-Digit Tone Open Number Code	Function
1st Digit Relay 1- 9 Relay 2- 5	Momentary activation. Relay will activate for the programmed strike time (3.1.3).
2nd Digit Relay 1- 8 Relay 2- 4	Relay hold. Relay will activate and remain activated until commanded to release.
3rd Digit Relay 1- 7 Relay 2- 3	Relay release. Deactivates the relay hold command.
4th Digit Relay 1- 6 Relay 2- 2	Relay hold 1-hour. Relay will activate for 1-hour and then will automatically deactivate itself.

4. Repeat steps 2 and 3 to set other relay tone open numbers.
5. Press **0 #** together to end this programming sequence (beeeeeep).

Note: Residents will only be able to activate the **Momentary activation** when using the entry system.

3.1.7 Programming Switch Input 1 and Switch Input 2

This programming sequence will set how the **TWO switch inputs** on the telephone entry system control board will operate. Switch input 1 is labeled **PSW** (postal switch) and is found on terminal 4 of the main terminal strip. Switch input 2 is a two terminal auxiliary input located on the upper left hand corner of the control board. These switch inputs can be programmed to activate their respective relays (switch 1 - relay 1, switch 2 - relay 2). They can also be programmed so that switch 1 dials out the phone number programmed in directory code 0, 00, 000, or 0000, and switch 2 dials out the phone number programmed in directory code 1, 01, 001, or 0001. Each switch is programmed independently.

Factory setting = Switch input 1 = 0 (relay 1 activates), Switch input 2 = 0 (relay 2 activates).

1. Press *** 2 3** and enter your four-digit MASTER CODE **?? ??** (beep).
2. Press **1 *** (beep) to set **Switch Input 1**, OR **2 *** (beep) to set **Switch Input 2**.
3. Press **0 *** (beep) to set **to activate the relay**, OR **1 *** (beep) to set **the switch input to dial-out a preprogrammed phone number**.
4. Press **0 #** together to end this programming sequence (beeeeeep).

3.1.8 Number of Rings Before Telephone Entry System will Answer

This programming sequence sets the number of rings to allow before the telephone entry system answers a call placed to it. This programming sequence **does not affect** the number of times that a resident's telephone will ring when a call is placed from the entry system to the resident.

Factory setting = 02 (two rings).

1. Press *** 1 8** and enter your four-digit MASTER CODE **?? ??** (beep).
2. Enter a two-digit **number of rings**, then press ***** (beep).
3. Press **0 #** together to end this programming sequence (beeeeeep).

3.1.9 PBX Line Access Code Programming

If the telephone entry system is connected to a **PBX telephone system** rather than a dedicated C.O. line, you may need to set the unit to dial a line access code prior to dialing the resident phone number. Typically, the line access code is “9”, but check with the PBX system administrator to be sure.

1. Press *** 2 1** and enter your four-digit MASTER CODE **?? ??** (beep).
2. Enter the single-digit **line access code number**, then press ***** (beep).
3. Press **0 #** together to end this programming sequence (beeeeeep).

Note: To change a line access number, enter the correct number in step 2. To delete a line access number, enter **#** in step 2.

3.1.10 Star Key ***** Function

This programming sequence sets the function of the ***** key on the keypad during conversation. This key can be set to **hang-up** the entry system when pressed during conversation, or it can be programmed to **touch-tone** out during conversation. **Factory setting = 0 (hang-up).**

1. Press *** 2 7** and enter your four-digit MASTER CODE **?? ??** (beep).
2. Press **0 *** (beep) for **hang-up**, OR **1 *** (beep) for **touch-tone**.
3. Press **0 #** together to end this programming sequence (beeeeeep).

3.1.11 Keypad Function (DTMF Tone Programming)

This programming sequence sets the function of the **0** through **9** and the *****, **#** keys on the keypad during conversation. The keys can be set to **hang-up** the entry system when they are pressed during conversation, or they can be programmed to **DTMF tone** out during conversation. The later may be desirable if the entry system is used with an auto-attendant type telephone system where the caller is prompted to enter numbers from a touch-tone telephone.

TIP: If DTMF tones are required, program the **#** or ***** key to hang-up the system.

Factory setting = 0 for all numbers (hang-up).

1. Press *** 2 6** and enter your four-digit MASTER CODE **?? ??** (beep).
2. Enter the single-digit **desired key number**, then press ***** (beep).
3. Press **0 *** (beep) for **hang-up**, OR **1 *** (beep) for **touch-tone**.
4. Repeat steps 2 and 3 to program other keys.
3. Press **0 #** together to end this programming sequence (beeeeeep).

3.1.12 System to Stay On-Line or Hang Up after Touch Tone Number Pressed

This programming sequence provides a method for the telephone entry system to remain **on-line** after a resident has pressed the touch tone number to open the door or gate. Each relay can be set independently to either remain on line or hang up.

Factory setting = 1 (hang up after touch tone number pressed) for both relays.

1. Press *** 2 8** and enter your four-digit MASTER CODE **?? ??** (beep).
2. Press **1 *** (beep) for **relay 1**, OR **2 *** (beep) for **relay 2**.
3. Press **0 *** (beep) to **keep the system on-line**, OR **1 *** (beep) to make it **hang up**.
4. Repeat steps 2 and 3 to program other relay.
5. Press **0 #** together to end this programming sequence (beeeeeep).

3.1.13 Automatic Hang-up Function

This programming sequence determines when the phone system will automatically hang itself up after a predetermined time of inactivity. You can program the system to not hang-up (0), to hang-up after 5 sec of dial-tone (1), to hang-up after 15 sec of silence (2) or to hang-up after either 5 sec of dial-tone or 15 sec of silence (3).

Factory setting = 1 (hang-up after 5 sec of dial-tone).

1. Press ***40** and enter your four-digit MASTER CODE **????** (beep).
2. Enter the single-digit **hang-up code desired (0, 1, 2 or 3)**, then press **#** (beep).

Hang-up Code	Function
0	No hang-up.
1	Hang-up after 5 sec. of dial-tone (Factory setting).
2	Hang-up after 15 sec. of silence.
3	Hang-up after 5 sec. of dial-tone OR 15 sec. of silence.

3. Press **0#** together to end this programming sequence (beeeeeep).

3.2 Directory Code and Phone Number Programming

Up to 16-Digit Phone Numbers can be programmed into the phone system when using the factory default settings (sections 3.2.1 - 3.2.7). The phone system can store up to **600 Phone Numbers**. It has the capability of storing up to 1000 phone numbers. But to do this, it has to use the old software programs, which are much more complex to program don't offer nearly as many area codes to use. If more than 600 phone numbers are needed, then sections 3.2.8 - 3.2.13 **MUST** be used with the limitations of the old software but DoorKing **DOES NOT RECOMMEND** this.

3.2.1 Programming the Directory Code Length

This programming sequence sets the **directory code length to 1 - 2 - 3 or 4 digits**. If **11** or more resident names or telephone numbers are going to be programmed into the system, the directory code must be **at least two-digits**. If **101** or more resident names or telephone numbers are going to be programmed, the directory code must be **at least three-digits**.

Factory setting is three (3) digits.

CAUTION: After programming this sequence, it is **NOT** recommended changing the directory code length. Reprogramming this sequence in the future will delete **ALL** phone numbers and directory codes that have been **previously** programmed into the system.

1. Press *** 2 0** and enter your four-digit MASTER CODE **? ? ? ?** (beep).
2. Enter the **directory code digit length (1, 2, 3 or 4)**, then press ***** (beep).
3. Press **0 *** (beep) to **cancel this function**, OR **1 *** (beeeeeep) to **confirm the change**.
The programming sequence will **automatically** end itself after pressing **1 ***. This **CANNOT** be **UNDONE!**

3.2.2 # Key - Insert an Amount of "Pause Time" Between Phone Number Digits

This programming sequence sets an OPTIONAL **Pause Time** that the **# Key** will program in if needed when dialing a **16-Digit Phone Number** in section 3.2.3. Insert the chosen **Pause Time (# Key)** between any phone number digits that need a pause when dialing. **# Key** can be used multiple times when programming a 16-digit phone number.

Note: **# Key "Pause Time"** will NOT function when 7-Digit Phone number programming is used, section 3.2.10.

Factory setting is 0 (0 sec).

1. Press *** 4 2** and enter your four-digit MASTER CODE **? ? ? ?** (beep).
2. Enter the **seconds of pause single-digit (0 to 9 seconds)**, then press ***** (beep).
3. Press **0 #** together to end this programming sequence (beeeeeep).

3.2.3 Programming Phone Numbers - Up to 16-Digits

In this programming sequence, the **directory codes** and **phone numbers** (up to 16 digits) will be programmed into the system. Be sure you have programmed the directory code length that you desire as described in section 3.2.1.

Changing the directory code length (Section 3.2.1) AFTER programming the telephone numbers will ERASE ALL the phone numbers and directory codes that have been previously programmed in.

If you use **directory codes 0, 00, 000, 0000** and/or **1, 01, 001, 0001** remember that the talk time for these directory codes are **factory set to the maximum** and cannot be changed. Use these directory codes to program **management** or **emergency phone numbers**, which generally require longer conversation periods.

Max Phone Number Capacity	
600 (Factory Default)	1000 (using sections 3.2.8 - 3.2.13)

Note: The phone system can be programmed to store up to 1000 phone numbers ONLY when using sections 3.2.8 - 3.2.13 (7-Digit Phoner numbers and area codes) programming, but this requires more programming for each phone number used, setting up individual area code reference numbers etc. and is not recommended.

Important: The factory default setting is 16-digit phone numbers. Section 3.2.8: *45 7-digit phone numbers **MUST NOT** have been reprogrammed ON (1 - YES). If it has been, section 3.2.9 *44 16-digit phone numbers **MUST** be reprogrammed ON (1 - YES) before proceeding and **ALL previously programmed phone numbers WILL be eased.**

1. Press ***01** and enter your four-digit MASTER CODE **????** (beep).
2. Choose and enter a **directory code (1, 2, 3 or 4 digits)**, depending on what was programmed in 3.2.1), then press ***** (beep).
Note: Use the log tables in back of this manual to keep track of names, phone numbers and directory codes.
3. Enter the **phone number** (Up to 16-digits, but less digits will be accepted) for the chosen directory code, then press ***** (beep).
Note: Entering the **#** anywhere in the phone number (multiple #'s can be used) will cause the dialing sequence to pause (1-9 seconds) if necessary, whatever was programmed in section 3.2.2.

Example: Phone number 1-904-359-6679 needs to be dialed with a pause after the 1.

Programming: **1#9043596679***

Important Note: If you make a mistake while programming, press **0#** keys at the same time to escape from programming no matter how much has been completed, then begin again at step 1.

4. Repeat steps 2 and 3 to enter additional **directory codes** and **phone numbers**.
5. Press **0#** together to end this programming sequence (beeeeeep).

3.2.4 Deleting Individual Phone Number

This programming sequence is used to delete a **SINGLE** phone number under a known directory code.

Note: This programming will **NOT** work for 7-Digit Phone Number programming, use section 3.2.13.

1. Press ***01** and enter your four-digit MASTER CODE **????** (beep).
2. Enter the **directory code (1, 2, 3 or 4 digits)**, depending on what was programmed in 3.2.1), then press ***** (beep).
3. Press ***** (beep) again. This **CANNOT** be **UNDONE!**
4. Repeat steps 2 and 3 to delete additional **phone numbers**.
5. Press **0#** together to end this programming sequence (beeeeeep).

3.2.5 Deleting ALL Phone Numbers

This programming step deletes **ALL** phone numbers previously programmed into the system.

CAUTION: This programming step **CANNOT** be **UNDONE!**

1. Press ***22** and enter your four-digit MASTER CODE **????** (beep).
2. Enter **9999**, then press ***** (beep). This **CANNOT** be **UNDONE!**

This programming sequence will automatically end itself by a long (beeeeeep).

3.2.6 Display / DELETE Phone Numbers with UNKNOWN Directory Codes

For 1803 & 1810 models **ONLY**. This program sequence is useful to display phone numbers when you **DO NOT KNOW** what directory code they have been programmed under. This sequence also gives you the option to **delete the phone number** after it is displayed.

1. Press ***25** and enter your four-digit MASTER CODE **????** (beep).
2. The first directory code will be displayed on the LCD screen. Press ***** to view the phone number under this directory code. **7-Digit Phone Number Programming ONLY Note:** The first directory code will be displayed on the LCD screen. The phone number, area code reference number and area code programmed under this directory code. The telephone number will display for 2 seconds, then the area code reference number and area code will display for 2 seconds. This sequence will repeat itself.
3. Press ***** to go to the next step.
4. Press ***** to move forward to the next directory code, OR press **0** to **DELETE the displayed phone number** and move forward to the next directory code. This **CANNOT** be **UNDONE!**

After the last phone number is displayed and ***** OR **0** is pressed, this programming sequence will automatically end itself by a long (beeeeeep) OR you can press **0#** TOGETHER to end this programming sequence at **ANY** time (beeeeeep).

3.2.7 Display Phone Numbers with KNOWN Directory Codes

For 1803 & 1810 models **ONLY**. Use this programming sequence to display phone numbers programmed under **known directory codes**, i.e. if you wanted to see what is programmed under directory code 2719 (assuming directory codes have been programmed for **four digits** in 3.2.1). This programming sequence will **NOT ALLOW** you to delete phone numbers.

1. Press ***06** and enter your four-digit MASTER CODE **????** (beep).
2. Enter the **known directory code** you wish to display the information for (**1, 2, 3 or 4 digits**, depending on what was programmed in 3.2.1), then press ***** (beep).
3. The information programmed under the directory code entered in step 2 will appear on the LCD display. If **C C C C C C C** appears, this indicates that **NO phone number** has been programmed under the entered directory code. **7-Digit Phone Number Programming ONLY Note:** The information programmed under the directory code entered in step 2 will appear on the LCD display. The telephone number will display for 2 seconds, then the area code reference number and area code will display for 2 seconds. This sequence will repeat itself. If **C C C C C C C** appears, this indicates that **NO phone number** has been programmed under the entered directory code. If the first digit is **flashing**, this is the area code reference number and indicates that the number displayed is a **long distance phone number**.
4. To display additional phone numbers press ***** and repeat step 2.
5. Press **0#** together to end this programming sequence (beeeeeep).

7-Digit Phone Number Programming - Limited Use

7-Digit Phone Number programming sections 3.2.8 - 3.2.13 will **ONLY** need to be used when **more than 600 Phone Numbers are needed** (not typical) OR **installing an OLD memory chip** in a NEW phone entry system (from an old phone system that has previously programmed information on it). DoorKing does not recommend using an old memory chip. Reprogramming the new memory chip with existing information will take some time but will save time when programming and operating the unit in the future.

DoorKing **DOES NOT RECOMMEND** using 7-Digit Phone Number programming for a NEW phone system. It is more complex to program and limits the features available compared to 16-Digit Phone Number programming.

Section 3.2.1 - "Directory Code Length" **MUST** be programmed before section 3.2.10 can be programmed.

Section 3.2.2 - "Pause Time" # key will **NOT** function when programming 7-Digit Phone Numbers.

Section 3.2.4 - "Delete Individual Phone Number" will **NOT** work for 7-Digit Phone Number programming. Use section 3.2.13.

Sections 3.2.5 - 3.2.7 - "Delete and Display" programming **WILL** function when using 7-Digit Phone Number programming.

Section 3.2.8 - "7-Digit Phone Number Capability" **MUST** be programmed to YES before section 3.2.10 can be programmed.

3.2.8 7-Digit Phone Number Capability

This programming sequence will change the factory set 16-Digit Phone Number programming to 7-Digit Phone Number programming. DoorKing **DOES NOT RECOMMEND** using 7-Digit Phone Number programming for a NEW phone entry system. **Factory setting is 0 (NO).**

CAUTION: If 7-digit programming is turned ON (1=YES), **All previously programmed phone numbers and directory codes** will be **ERASED**.

1. Press and enter your four-digit MASTER CODE (beep).

2 sec. LCD display on 1803 & 1810 models will read: 7 DIG?.

...then the LCD display will read: 1=Y 0=N.

2. Press (beep) for **YES**, OR (beep) for **NO**.

The 1 "YES" LCD display will read: ERASING. This **CANNOT** be **UNDONE!** Programming sequence will automatically end itself when finished by a long (beeeeeep).

3.2.9 16-Digit Phone Number Capability

This programming sequence **DOES NOT** need to be changed when using 16-Digit Phone Number programming. This **ONLY** needs to be turned back **ON** (1=YES) if you want to change 7-Digit Phone Number programming back to 16-Digit Phone Number programming. DoorKing **ALWAYS RECOMMENDS** using 16-Digit Phone Number programming for a phone entry system.

Factory setting is 1 (YES).

CAUTION: If this programming is turned back ON (1=YES), **All previously programmed phone numbers and directory codes** will be **ERASED**.

1. Press and enter your four-digit MASTER CODE (beep).

2 sec. LCD display on 1803 & 1810 models will read: 16 DIG?.

...then the LCD display will read: 1=Y 0=N.

2. Press (beep) for **YES**, OR (beep) for **NO**.

The 1 "YES" LCD display will read: ERASING. This **CANNOT** be **UNDONE!** Programming sequence will automatically end itself when finished by a long (beeeeeep).

3.2.10 Programming 7-Digit Phone Numbers

In this programming sequence, the **directory codes** and **7-digit phone numbers** will be programmed into the system. Be sure you have programmed **section 3.2.8** to YES (7-digit capability) and the directory code length that you desire in **section 3.2.1**. **Changing the directory code length AFTER programming the telephone numbers will ERASE ALL the phone numbers and directory codes that have been previously programmed in.** To program phone numbers that will be referenced to an area code (long distance calls and 10 digit calling), follow the instructions under **3.2.11 Long Distance Phone Number Programming** below. If you use **directory codes 0, 00, 000, 0000** and/or **1, 01, 001, 0001** remember that the talk time for these directory codes are **factory set to the maximum** and cannot be changed. Use these directory codes to program **management** or **emergency phone numbers**, which generally require longer conversation periods.

Note: If this telephone entry system is being used in an area that requires **10-digit dialing**, proceed to 3.2.11 and 3.2.12 to program the **area code** and **phone number**. **DO NOT** program 7-digit numbers.

1. Press ***01** and enter your four-digit MASTER CODE **????** (beep).
2. Choose and enter a **directory code (1, 2, 3 or 4 digits**, depending on what was programmed in 3.2.1), then press ***** (beep).
3. Enter a seven-digit **phone number** for the chosen directory code, then press ***** (beep).
If the number that you are entering in this step is LESS than seven-digits, enter # in the empty spaces. For example, if the system is connected to a PBX that requires four-digit extension numbers and you want to enter extension 2217, you would enter this number as: **2217####** then press ***** (beep).
4. Repeat steps 2 and 3 to enter additional **directory codes** and **phone numbers**.
5. Press **0#** together to end this programming sequence (beeeeeep).

3.2.11 Programming Area Codes (Area Code Reference Numbers)

Up to **15 different area codes** can be programmed for any 10-digit or long distance calling requirements and will be referenced as area code reference number **01 through 15**. The area codes will be entered as a four-digit number (1 + the three digit area code, example: 1203). If area codes are being programmed to facilitate 10-digit calling requirements, precede the three-digit area code with # (example: #203).

1. Press ***24** and enter your four-digit MASTER CODE **????** (beep).
2. Choose and enter a two-digit **area code reference number (01 through 15)** that will reference area code to be programmed, then press ***** (beep).
3. Enter the four-digit **area code**, then press ***** (beep).
For **long distance** calling requirements: enter **1** and the three-digit area code (example: 1203).
For **10-digit** calling requirements: enter **#** and the three-digit area code (example: #203).
4. Repeat steps 2 and 3 to enter additional **area codes**. Use a **different** area code reference number for each area code programmed when entering more than one area code (up to 15).
5. Press **0#** together to end this programming sequence (beeeeeep).

Use these tables to keep track of area codes programmed in. Complete log table in back of manual when finished.

Area Code Reference Number	Area Code
01	
02	
03	
04	
05	
06	
07	
08	

Area Code Reference Number	Area Code
09	
10	
11	
12	
13	
14	
15	

3.2.12 Programming Phone Numbers WITH Area Code Reference Numbers

Program phone numbers that are referenced to an area code (**long distance and 10-digit dialing calls**). Make sure that the area code(s) have already been programmed with area code reference numbers in previous section 3.2.11. Be sure you have programmed **section 3.2.8** to YES (7-digit capability) and the directory code length that you desire in **section 3.2.1**.

Note: If long distance or 10-digit dialing is **NOT required**, program the 7-digit telephone numbers as described in section 3.2.10.

1. Press ***41** and enter your four-digit MASTER CODE **????** (beep).
2. Choose and enter a **directory code (1, 2, 3 or 4 digits**, depending on what was programmed in 3.2.1), then press ***** (beep).
3. Enter the two-digit **area code reference number (01 through 15)**, then press ***** (beep).
See tables on previous page and log tables in back of this manual for area code reference numbers that have been programmed in.
4. Enter a seven-digit **phone number** for the chosen directory code, then press ***** (beep).
If the number that you are entering in this step is LESS than seven-digits, enter # in the empty spaces. For example, if the system is connected to a PBX that requires four-digit extension numbers and you want to enter extension 2217, you would enter this number as: **2217####** then press ***** (beep).
5. Repeat steps 2, 3 and 4 to enter additional **long distance phone numbers**.
6. Press **0#** together to end this programming sequence (beeeeeep).

3.2.13 Deleting Individual 7-Digit Phone Number

This programming sequence is used to delete a **SINGLE** phone number under a known directory code using the **7-Digit Phone Number Programming ONLY**. Note: Use section 3.2.4 when using factory default 16-Digit Phone Number Programming.

1. Press ***01** and enter your four-digit MASTER CODE **????** (beep).
2. Enter the **directory code (1, 2, 3 or 4 digits**, depending on what was programmed in 3.2.1), then press ***** (beep).
3. Enter **#####**, then press ***** (beep). This **CANNOT** be **UNDONE!**
4. Repeat steps 2 and 3 to delete additional **phone numbers**.
5. Press **0#** together to end this programming sequence (beeeeeep).

3.3 Entry Code Programming

3.3.1 Programming Four-Digit Entry Code

This programming sequence programs **four-digit entry codes** into the system memory. The number of four-digit entry codes that can be programmed is the same as the telephone number memory capacity, plus 12. We suggest that all entry codes that are programmed into the system be listed with the names of residents that they have been assigned to (see log tables in back of this manual).

Note: Temporary **four-digit entry codes** can be programmed into system that will only be active for 24 hours. See section 3.4.5 for more information about “Flash entry Codes” if this feature is desired (Time clock must be programmed, section 3.4.1).

1. Press *** 0 2** and enter your four-digit MASTER CODE **?? ??** (beep).
2. Enter the four-digit **entry code**, then press ***** (beep).
3. Repeat step 2 to enter **additional entry codes**.
4. Press **0 #** together to end this programming sequence (beeeeeep).

3.3.2 Delete Individual Four-Digit Entry Code

1. Press *** 1 4** and enter your four-digit MASTER CODE **?? ??** (beep).
2. Enter the four-digit **entry code** to be **deleted**, then press ***** (beep).
3. Repeat step 2 to delete **additional entry codes**.
4. Press **0 #** together to end this programming sequence (beeeeeep).

3.3.3 Delete ALL Four-Digit Entry Codes

This programming step deletes **ALL** four-digit entry codes that have been programmed into the system.

CAUTION: This programming **CANNOT** be **UNDONE!**

1. Press *** 0 0** and enter your four-digit MASTER CODE **?? ??** (beep).
2. Press **9 9 9 9** then press ***** (beep).
This programming sequence will automatically end itself by a long (beeeeeep).

3.3.4 Four-Digit Entry Code Divide Number to Activate Relays

The **four-digit entry codes** can be made to **activate** either **relay 1** or **relay 2** by programming a **four-digit divide number**. Four-digit entry codes **equal to** or **less than** the divide number will **activate relay 1**. Four-digit entry codes **greater than** the divide number will **activate relay 2**.

TIP: you can make **ALL** four-digit entry codes (except 0000) activate **Relay 2** by programming divide number 0000, or make **ALL** four-digit entry codes activate **Relay 1** by programming divide number 9999.

Factory default divide number is 9999 - Activates Relay 1.

1. Press *** 1 2** and enter your four-digit MASTER CODE **?? ??** (beep).
2. Enter the four-digit **divide number**, then press ***** (beep).
3. Press **0 #** together to end this programming sequence (beeeeeep).

3.3.5 "Hold Four-Digit Entry Codes" - Reverse Relay Activation ONLY

A four-digit entry code can be programmed to reverse the condition of relay 1 or relay 2 ONLY. If a relay is NOT activated, entering one of these entry codes will activate it and keep it activated (Hold). If a relay is activated, entering one of these entry codes will release it. (4) entry codes can be assigned to each relay using specific Hold Code numbers. DO NOT use existing four-digit entry codes that were programmed in from section 3.4.1. Rev P circuit board or higher ONLY.

Hold four-digit entry code will override any hold open sequence that is in progress and close the gate immediately.

Hold code numbers 1 through 4 are assigned to Relay 1 ONLY (one four-digit entry code per hold code number).

Hold code numbers 5 through 8 are assigned to Relay 2 ONLY (one four-digit entry code per hold code number).

1. Press ***** **1** **9** and enter your four-digit MASTER CODE **?** **?** **?** **?** (beep).
2. Enter a single-digit **hold code number** (1-4:Relay 1, 5-8:Relay 2), then press ***** (beep).
3. Enter a four-digit **entry code**, then press ***** (beep). Fill in table below and in back of this manual.
4. Repeat steps 2 and 3 to enter additional Hold four-digit entry codes (up to 8 codes total).
5. Press **0** **#** together to end this programming sequence (beeeeeep).

Relay 1 Hold Code	Hold Four-Digit Entry Code
1	
2	
3	
4	

Relay 2 Hold Code	Hold Four-Digit Entry Code
5	
6	
7	
8	

3.3.6 Programming Five-Digit Entry Code

This programming sequence programs **five-digit entry codes** into the system memory. The number of five digit entry codes that can be programmed is **limited to six**. We suggest that all entry codes that are programmed into the system be listed with the names of residents that they have been assigned to (see log tables in back of this manual).

1. Press ***** **0** **9** and enter your four-digit MASTER CODE **?** **?** **?** **?** (beep).
2. Enter the five-digit **entry code**, then press ***** (beep).
3. Repeat step 2 to enter **additional entry codes**.
4. Press **0** **#** together to end this programming sequence (beeeeeep).

3.3.7 Delete Individual Five-Digit Entry Code

1. Press ***** **1** **0** and enter your four-digit MASTER CODE **?** **?** **?** **?** (beep).
2. Enter the five-digit **entry code** to be **deleted**, then press ***** (beep).
3. Repeat step 2 to delete **additional entry codes**.
4. Press **0** **#** together to end this programming sequence (beeeeeep).

3.3.8 Delete ALL Five-Digit Entry Codes

This programming step deletes **ALL** five-digit entry codes that have been programmed into the system.

CAUTION: This programming **CANNOT** be **UNDONE!**

1. Press ***** **1** **1** and enter your four-digit MASTER CODE **?** **?** **?** **?** (beep).
2. Press **9** **9** **9** **9** then press ***** (beep).

This programming sequence will automatically end itself by a long (beeeeeep).

3.3.9 Five-Digit Entry Code Divide Number to Activate Relays

The **five-digit entry codes** can be made to **activate** either **relay 1** or **relay 2** by programming a **five-digit divide number**. Five-digit entry codes **equal to** or **less than** the divide number will **activate relay 1**. Five-digit entry codes **greater than** the divide number will **activate relay 2**.

TIP: you can make **ALL** five-digit entry codes (except 0000) activate **Relay 2** by programming divide number 00000, or make **ALL** five-digit entry codes activate **Relay 1** by programming divide number 99999.

Factory default divide number is 99999 - Activates Relay 1.

1. Press ***** **1** **3** and enter your four-digit MASTER CODE **?** **?** **?** **?** (beep).
2. Enter the five-digit **divide number**, then press ***** (beep).
3. Press **0** **#** together to end this programming sequence (beeeeeep).

3.4 Time Functions Programming

3.4.1 Programming Time Clock

This programming sequence programs the calendar chip in the telephone entry system for the current time and date. The calendar chip **MUST** be programmed if you are going to use any of the time functions available with the entry system.

1. Press *** 3 3** and enter your four-digit MASTER CODE **? ? ? ?** (beep).
2. Enter the four-digit **current hour and minutes**, then press ***** (beep).
DO NOT use military (24 hour) time format, simply enter the hour (2 digits) and the minutes (2 digits). For example, 8:30 is entered as 0830. AM or PM gets set on the next step.
3. Press **0 *** (beep) for **AM**, OR **1 *** (beep) for **PM**.
4. Enter the two-digit **month**, then press ***** (beep).
5. Enter the two-digit **day of the month**, then press ***** (beep).
6. Enter the two-digit **year**, then press ***** (beep).
7. Enter the single-digit **day of the week** (Sun = 1, Mon = 2,Sat = 7) then press ***** (beeeeeep).

3.4.2 Automatic Relay Activation Time Zones

This program sequence sets up to **FOUR time zones** to **automatically activate** and **deactivate** the **relays** on the control board. Each relay can be programmed with **TWO independent time zones**.

Time zones 1 and 2 controls **Relay 1** operation ONLY.

Time zones 3 and 4 controls **Relay 2** operation ONLY.

Use the chart in the log tables in back of this manual to record the time zones that are programmed. These time zones can be independently turned ON or turned OFF after they have been programmed (see operating instructions 4.2.5 to turn ON or OFF the programmed time zones).

1. Press *** 3 5** and enter your four-digit MASTER CODE **? ? ? ?** (beep).
2. Enter a single-digit **time zone number** (1 or 2 = relay 1, 3 or 4 = relay 2), then press ***** (beep).
3. Press **1 *** (beep) to turn **time zone ON**, OR **0 *** (beep) to turn **time zone OFF**.
4. Enter the four-digit **BEGINNING hour and minutes**, then press ***** (beep).
DO NOT use military (24 hour) time format, simply enter the hour (2 digits) and the minutes (2 digits). For example, 8:30 is entered as 0830. AM or PM gets set on the next step.
5. Press **0 *** (beep) for **AM**, OR **1 *** (beep) for **PM**.
6. Enter the four-digit **ENDING hour and minutes**, then press ***** (beep).
DO NOT use military (24 hour) time format, simply enter the hour (2 digits) and the minutes (2 digits). For example, 8:30 is entered as 0830. AM or PM gets set on the next step.
7. Press **0 *** (beep) for **AM**, OR **1 *** (beep) for **PM**.
8. Enter the seven-digit **days of the week**, then press ***** (beeeeeep). (Sun = 1, Mon = 2,Sat = 7)
All seven digits **MUST** be entered, to skip any days of the week the time zone will **NOT** be active, enter # in place of a day.
Example 1, to have a time zone active on Saturday and Sunday ONLY (Sun = 1, Sat = 7), enter **1 7 # # # # #**.
Example 2, to have a time zone active on Monday thru Friday ONLY (Mon = 2, Tues = 3,Fri = 6), enter **2 3 4 5 6 # #**.
9. Repeat steps 2 through 8 to **enter additional time zones**.
10. Press **0 #** together to end this programming sequence (beeeeeep).

3.4.3 Four-Digit Entry Codes Time Zone

This programming sequence sets up **ONE time zone** for the **FOUR-digit entry codes** to activate the system relays. This time zone uses a range of four-digit entry codes (Boundary numbers) and can be programmed for certain days of the week. This time zone can be turned ON and turned OFF after it is programmed (see operating instructions 4.2.4 to turn ON or OFF the programmed entry code time zone).

1. Press *** 3 6** and enter your four-digit MASTER CODE **? ? ? ?** (beep).

2. Press **1 *** (beep) to turn **time zone ON**, OR **0 *** (beep) to turn **time zone OFF**.

3. Enter the four-digit **BEGINNING hour and minutes**, then press ***** (beep).

DO NOT use military (24 hour) time format, simply enter the hour (2 digits) and the minutes (2 digits). For example, 8:30 is entered as 0830. AM or PM gets set on the next step.

4. Press **0 *** (beep) for **AM**, OR **1 *** (beep) for **PM**.

5. Enter the four-digit **ENDING hour and minutes**, then press ***** (beep).

DO NOT use military (24 hour) time format, simply enter the hour (2 digits) and the minutes (2 digits). For example, 8:30 is entered as 0830. AM or PM gets set on the next step.

6. Press **0 *** (beep) for **AM**, OR **1 *** (beep) for **PM**.

7. Enter the seven-digit **days of the week**, then press ***** (beeeeeep). (Sun = 1, Mon = 2,Sat = 7)

All seven digits **MUST** be entered, to skip any days of the week the time zone will **NOT** be active, enter # in place of a day.

Example 1: to have a time zone active on Saturday and Sunday **ONLY** (Sun = 1, Sat = 7), enter **1 7 # # # # #**.

Example 2: to have a time zone active on Monday thru Friday **ONLY** (Mon = 2, Tues = 3,Fri = 6), enter **2 3 4 5 6 # #**.

8. Enter the **LOWER** four-digit entry codes **boundary number**, then press ***** (beep).

Entry codes **LOWER** than this number will **NOT** activate relays when the entry code time zone is ON.

9. Enter the **UPPER** four-digit entry codes **boundary number**, then press ***** (beep).

Entry codes **HIGHER** than this number will **NOT** activate relays when the entry code time zone is ON.

10. Press **0 #** together to end this programming sequence (beeeeeep).

3.4.4 Five-Digit Entry Codes Time Zone

This programming sequence sets up **ONE time zone** for the **FIVE-digit entry codes** to activate the system relays. This time zone uses a range of five-digit entry codes (Boundary numbers) and can be programmed for certain days of the week. This time zone can be turned ON and turned OFF after it is programmed (see operating instructions 4.2.4 to turn ON or OFF the programmed entry code time zone).

Note: FLASH entry codes can NOT be used with five-digit entry codes.

1. Press *** 3 7** and enter your four-digit MASTER CODE **? ? ? ?** (beep).

2. Press **1 *** (beep) to turn **time zone ON**, OR **0 *** (beep) to turn **time zone OFF**.

3. Enter the four-digit **BEGINNING hour and minutes**, then press ***** (beep).

DO NOT use military (24 hour) time format, simply enter the hour (2 digits) and the minutes (2 digits). For example, 8:30 is entered as 0830. AM or PM gets set on the next step.

4. Press **0 *** (beep) for **AM**, OR **1 *** (beep) for **PM**.

5. Enter the four-digit **ENDING hour and minutes**, then press ***** (beep).

DO NOT use military (24 hour) time format, simply enter the hour (2 digits) and the minutes (2 digits). For example, 8:30 is entered as 0830. AM or PM gets set on the next step.

6. Press **0 *** (beep) for **AM**, OR **1 *** (beep) for **PM**.

7. Enter the seven-digit **days of the week**, then press ***** (beeeeeep). (Sun = 1, Mon = 2,Sat = 7)

All seven digits **MUST** be entered, to skip any days of the week the time zone will **NOT** be active, enter # in place of a day.

Example 1: to have a time zone active on Saturday and Sunday **ONLY** (Sun = 1, Sat = 7), enter **1 7 # # # # #**.

Example 2: to have a time zone active on Monday thru Friday **ONLY** (Mon = 2, Tues = 3,Fri = 6), enter **2 3 4 5 6 # #**.

8. Enter the **LOWER** five-digit entry codes **boundary number**, then press ***** (beep).

Entry codes LOWER than this number will **NOT** activate relays when the entry code time zone is ON.

9. Enter the **UPPER** five-digit entry codes **boundary number**, then press ***** (beep).

Entry codes HIGHER than this number will **NOT** activate relays when the entry code time zone is ON.

10. Press **0 #** together to end this programming sequence (beeeeeep).

3.4.5 "Flash Entry Codes" - Active for ONE-DAY ONLY

This programming sequence sets up "**Flash Entry Codes**". Flash codes are **four-digit entry codes** that will operate **ONLY ONE TIME** on a **specific day of the month** - they will not operate **before** or **AFTER** the programmed day. The flash codes will be valid for a **single 24-hour period ONLY**. For example, if you program a flash code on July 1st to be active on the 10th, the code will become valid at 12:00 AM on July 10th and expire at 11:59 PM on July 10th. The code will not be valid on August 10th. You can program up to **EIGHT flash codes** in the system.

Flash code numbers **1** through **4** will activate **Relay 1 ONLY**.

Flash code numbers **5** through **8** will activate **Relay 2 ONLY**.

1. Press *** 1 5** and enter your four-digit MASTER CODE **? ? ? ?** (beep).

2. Enter a single-digit **flash code number (1-8 depending on which relay is to be activated)**, then press ***** (beep).

3. Enter the two-digit **day of the month that the code is to be active**, then press ***** (beep).

4. Enter a desired four-digit **FLASH ENTRY CODE**, then press ***** (beep).

6. Repeat steps 2 through 4 to enter additional desired **FLASH ENTRY CODES**.

4. Press **0 #** together to end this programming sequence (beeeeeep).

SECTION 4 - SYSTEM OPERATING INSTRUCTIONS

4.1 General Instructions

4.1.1 Guest Instructions

Instructions on the faceplate of the unit will instruct guest on the operation of the telephone entry system. Guests will locate a residents name and directory code in a directory associated with the telephone entry system. This may be a letter board type directory, an add-on directory or a built-in directory like that found in the 1810 or 1808 with directory units. When a directory code is entered on the system keypad, the telephone entry system will call the preprogrammed telephone number stored under that directory code. If the line is busy, the system will emit a busy signal. Pressing the hang-up key (any key or the preprogrammed hang-up key) will hang the system up. Guest can then try again. Residents can avoid missing calls from the telephone entry system by ordering **call waiting** from the local telephone company.

The system can be programmed so that the system keypad emits DTMF tones after a connection is made. For example, in a business application, a call from the telephone entry system may be answered by an auto-attendant requesting that you enter a person's extension number. This is possible with the system provided that it has been programmed to emit DTMF tones once the call is answered.

4.1.2 Responding to a Guest Call

When communication is established, the resident has the option of opening the door(s) or gate(s) by pressing the programmed tone open number(s) on their touch tone telephone, or they can deny access to their guest by pressing # on their telephone. If access is granted, the resident will hear a confirmation tone in their handset indicating that the door or gate has opened, then the system will automatically hang up.

Residents should be instructed by management to always press the # key on their telephone if they wish to **deny a guest access**. If a resident hangs up to deny access instead of pressing #, the telephone entry system will remain on line until its programmed talk time expires or until it detects dial tone.

Some newer type telephones emit a short tone rather than a continuous tone when their keys are pressed. This may cause the telephone entry system to **not respond to the tone open number**. If this happens, simply press the tone open number twice in rapid succession to open the door or gate.

If a resident is using **rotary dial telephone**, they will grant access to their guest by dialing **9**. To deny access to their guest, residents with rotary phones must simply **hang up**.

4.1.3 Using an Entry Code

The FOUR and FIVE-digit entry codes will operate either relay 1, relay 2, or they can be programmed so that certain codes will activate only relay 1 while others will activate only relay 2. Both four and five-digit entry codes can be time zone restricted.

FOUR-Digit Entry Code - Press  and then enter your four-digit Entry Code    

FIVE-Digit Entry Code - Press   and then enter your five-digit Entry Code     

If management decides to utilize resident entry codes, residents should be instructed to keep their unique code **secret**. Telling other persons their code or allowing other persons to use their code compromises security and defeats the purpose of the system.

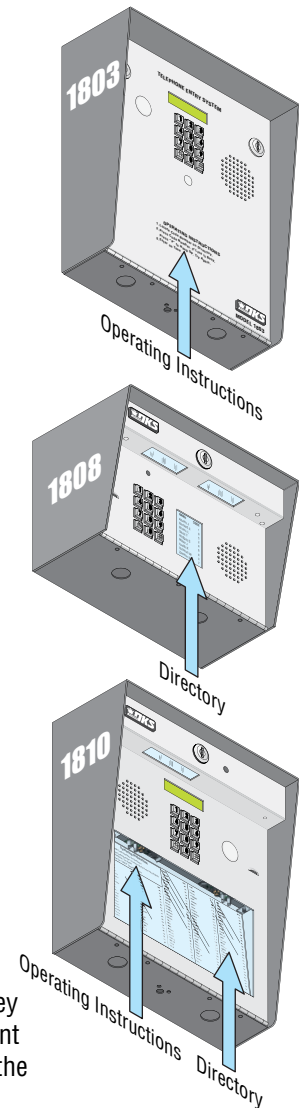

4.2 System Administrator

The administrator can perform the following operations from a **remote** location (off-site) using a **touch-tone telephone**. You must know:

- The phone number of the system.
- The system's four-digit MASTER CODE.
- If the system is using DKS Cellular, VoIP or POTS telephone line for communications.

IMPORTANT: Cellular or VoIP communication **may not allow** off-site programming from a phone depending on the clarity of the DTMF tones (Dual-Tone Multi-Frequency) the entry system is receiving from the phone.



TIP: LCD screen on a phone will make programming **MUCH** easier.

4.2.1 Remote Programming (Touch-Tone Phone)

1. Call the telephone number that the entry system is installed on. The system will answer with a short tone (**beep heard**).
Note: the number of rings before the system answers is dependent on the programming in 3.1.8.
2. After the system answers, follow the desired programming steps in Section 3.
3. When complete, hang up. You cannot use **0 #** together to end the programming step from a touch-tone telephone.

4.2.2 Remote Relay Activation

1. Call the telephone number that the entry system is installed on. The system will answer with a short tone (**beep heard**).
Note: You must know if the system is on a **DKS Cellular, VoIP OR a POTS telephone line**.
Note: the number of rings before the system answers is dependent on the programming in 3.1.8.
2. Press ***16** and enter the four-digit MASTER CODE (**beep heard**).
3. Press the desired single-digit tone open number (**beep heard**).
Note: Refer to 3.1.5 to determine which tone open features have been programmed, i.e. momentary open, hold open, release, hold open one hour and then release. Refer to 6.1 log table in back of manual to reference specific programming.
4. Hang up.

4.2.3 Remote Relay Check

The telephone entry system can be called and a check can be made to determine if any of the relays in the system are in a "**Hold Open**" mode. This check can be useful if your gate (or door) is held open and you suspect that the telephone entry system relay may be the cause.

1. Call the telephone number that the entry system is installed on. The system will answer with a short tone (**beep heard**).
Note: You must know if the system is on a **DKS Cellular, VoIP OR a POTS telephone line**.
Note: the number of rings before the system answers is dependent on the programming in 3.1.8.
2. Press ***16** and enter the four-digit MASTER CODE (**beep heard**).
3. The system will emit a series of short tones if the relay is in a **continuous** activation mode.
Relay 1 activated: **beep** - pause - **beep** - pause . . .
Relay 2 activated: **beep beep** - pause - **beep beep** - pause . . .
Relay 1 & 2 activated: **beep beep beep** - pause - **beep beep beep** - pause . . .
4. Press the programmed single-digit tone number to deactivate the relay (**beep heard**). The system will automatically hang up.
Note: the single-digit tone number is dependent on the programming in 3.1.6 (factory defaults: Relay 1 - **7**, Relay 2 - **3**).

4.2 System Administrator Continued

4.2.4 Remote Entry Code Time Zone Enable / Disable

The entry code time zones can be turned **OFF** (disable) or **ON** (enable) remotely from a touch-tone telephone at any time without changing the time zone boundaries. To program the time zone boundaries, see sections 3.4.3 and 3.4.4. Entry code time zones can also be turned **off** or **on** at the system keypad by skipping step 1 and proceeding directly to step 2 in the sequence below.



TIP: LCD screen on a phone will make programming **MUCH** easier.

1. Call the telephone number that the entry system is installed on. The system will answer with a short tone (**beep heard**).
Note: the number of rings before the system answers is dependent on the programming in section 3.1.8.
2. Press ***36** for **FOUR-digit entry code time zones**, or ***37** for **FIVE-digit entry code time zones**, then enter the four-digit **MASTER CODE** (**beep heard**).
3. Press **0 *** (**beep heard**) to turn the time zone **OFF**, or press **1 *** (**beep heard**) to turn the time zone **ON**.
3. Hang up the phone or if at the system keypad, press **0 #** together (**beeeeeep**).

4.2.5 Remote Automatic Relay Time Zone Enable / Disable

The **four time zones** that automatically activate and deactivate the relays can be turned **OFF** (disable) or **ON** (enable) remotely from a touch-tone telephone at any time without changing the time zone programming. To program the automatic relay activation time zones, see section 3.4.2. The four Automatic relay time zones can also be turned **off** or **on** at the system keypad by skipping step 1 and proceeding directly to step 2 in the sequence below.

1. Call the telephone number that the entry system is installed on. The system will answer with a short tone (**beep heard**).
Note: the number of rings before the system answers is dependent on the programming in section 3.1.8.
2. Press ***35** and enter the four-digit **MASTER CODE** (**beep heard**).
3. Enter the single-digit time zone number that you want to turn OFF or ON, then press ***** (**beep heard**).
Note: Refer to section 3.4 to determine which time zones have been programmed into the system or see log tables in back of this manual.
4. Press **0 *** (**beep heard**) to turn the time zone **OFF**, or press **1 *** (**beep heard**) to turn the time zone **ON**.
5. Hang up the phone or if at the system keypad, press **0 #** together (**beeeeeep**).

IMPORTANT: Cellular or VoIP communication **may not allow** off-site programming from a phone depending on the clarity of the DTMF tones (Dual-Tone Multi-Frequency) the entry system is receiving from the phone.

4.3 Miscellaneous Operating Instructions

4.3.1 Switch Input 1 & 2 Operation

The **two switch inputs** can be programmed to either activate their respective relay (**switch input 1 activates relay 1; switch input 2 activates relay 2**) or they can be programmed to **call the phone number** programmed under the first two directory codes (**switch input 1** calls the phone number programmed under **directory code 0, 00, 000 or 0000**) (**switch input 2** calls the phone number programmed under **directory code 1, 01, 001 or 0001**). Each switch input is programmed independently (3.1.7). **Switch 1** input is typically used as the postal switch and is pre-wired and pre-programmed for postal switch operation. We suggest that switch input 1 should be left programmed to activate relay 1 to allow the mail carrier entry. **Switch 2** input can be programmed as the application requires. For example, if the telephone entry system is controlling a vehicular gate with relay 1 and a pedestrian gate with relay 2, a postal lock box (DoorKing P/N 1402-080) could be installed at the pedestrian gate for the mail carrier and connected to switch input 2. In this manner, the postal lock box would allow the mail carrier access through the pedestrian gate when it is activated. Another use of switch input 2 is to program the input to call a preprogrammed telephone number instead of activating relay 2. An auxiliary button can be installed and connected to switch input 2 and labeled "assistance". When the button is pressed, the system will automatically dial the phone number programmed under directory code 1, 01, 001 or 0001.

4.3.2 Talk Time

The talk time for directory codes 0, 00, 000, 0000 and 1, 01, 001, 0001 is **factory set to 4 minutes 15 seconds** and cannot be changed. These directory codes should be reserved for use with management or emergency phone numbers that typically require longer talk times. For example, if directory code 000 was programmed to call a management phone number, the system will allow the full 4 minutes and 15 seconds of talk time before automatically ending the call.

4.3.3 Phone Line Sharing for Multiple Telephone Entry Systems

More than one telephone entry system can **share the same phone line** provided that the units have been programmed for multiple systems on the same line (see 3.1.2). When the unit is programmed for multiple systems sharing the same line, it checks the phone line for 48 volts (not busy) before attempting to place a call. If the phone line is in use, the system will emit a busy signal. If two or more systems are sharing the same phone line, it is important that **each system be programmed with its own unique master code**. When more than one system is on the same phone line, and a call is placed from one of the systems to a resident, only the system that placed the call will respond to any tone open numbers. Do not be concerned that all the units will activate their relay when the resident presses the tone open number.

4.3.4 Connection to a PBX using 7-Digit Phone Number Programming ONLY

If the telephone entry system is going to be connected to a **PBX system**, you may need to program **extension numbers in place of a seven-digit telephone number**. To do this, enter the extension number and fill the remaining spaces with the # key in the phone number programming step.

For example, if the PBX system uses **four-digit extensions** and you want to program **extension 2217** as a phone number, in step 3, **section 3.2.10** press:

3. Enter **2 2 1 7 # # #**, then press ***** (beep).

If the PBX system requires you to **dial 9** to obtain an outside line, and you want to program some **outside line phone numbers** in the system, program the number **9** as one of the **alternate area codes**. In step 3, **section 3.2.11** press:

3. Enter **9 # # #**, then press ***** (beep). Then program the **outside phone number as a long distance number** (**section 3.2.12**) using the **area code reference number** used to program **9** as one of the **alternate area codes**.

4.3.5 Areas with 10-digit Dialing using 7-Digit Phone Number Programming ONLY

If the telephone entry system is installed in an area where the telephone company has instituted **10 digit dialing**, simply program the required number of **alternate area codes** into the system without preceding the area code with the number 1. For example, if 310 is one of the area codes required, in step 3, **section 3.2.11** press:

3. Enter **3 1 0 #**, then press ***** (beep). Then program the **outside phone number as a long distance number** (**section 3.2.12**) using the **area code reference number** used to program 310 as one of the **alternate area codes**. Program additional area codes and phone numbers as described in sections 3.2.11 and 3.2.12.

SECTION 5 - MAINTENANCE

The DoorKing telephone entry system is essentially a maintenance free device. When the unit is properly installed, it should provide years of trouble free service. Maintenance is limited to updating the directory and phone number and/or entry codes when residents move in or out.

The faceplate of the unit should be cleaned on a regular basis to keep contaminants in the air from sticking to the surface and possibly causing pitting. When cleaning the faceplate of the system, **NEVER** use an abrasive cleaner or cloth. Stainless steel cleaner works very well with a soft cloth for systems with a stainless steel faceplate. A clean damp soft cloth should be used to clean gold plated faceplates.

5.1 Replacement Parts

The following items are replaceable and can be ordered from your installing dealer.

- Circuit Board Replacement Circuit Board P/N 1862-010 REV O or higher. 8-character LCD display P/N 1890-010.
- Keypad Replacement keypad – P/N 1895-017 num only
- Transformer Replacement power transformer – 16.5 VAC, 20 VA U.L. Listed DoorKing P/N 1804-060

5.2 Troubleshooting

If problems should develop with your telephone entry system, refer to the troubleshooting table below and on the following pages to try and correct any problems. Our experience has shown that a majority of reported problems are actually programming related and can be corrected on site. If problems persist and they cannot be corrected, contact your authorized DoorKing dealer for assistance. **Before performing any troubleshooting**, check the following:

1. Have a good VOM meter handy to check voltages and continuity.
2. Have a telephone test set (DoorKing P/N 1800-050 or equivalent) to check the telephone line. Noise on the phone line will cause problems with the entry system.
3. Be sure that the entry system case is properly grounded.
4. Be sure that the telephone wires are twisted.
5. A hum on the system indicates that the phone line or 16 VAC power lines may be grounded. Check to be sure that the phone lines or power lines are not shorted to ground.
6. Check the 16 VAC system power. Be sure that the transformer is properly rated (16 VAC, 20 VA). Keep the wire run from the transformer to the entry system as short as possible. Use 16 or 18 AWG, 600 volt insulated wire only. **The importance of proper power wiring cannot be over stressed!**
7. Isolate the telephone entry system. Disconnect any external devices, such as gate operators, electric strikes, magnetic locks, etc., which may affect the operation of the system.

Symptom	Possible Solution(s)
Cannot get into programming mode.	<ul style="list-style-type: none"> • Wrong master code entered. Start over. • Waiting too long between pushing buttons. Enter information quicker. • Keypad is not plugged into board correctly. Cable points down. • Memory chip is installed upside down (Section 1.5).
System emits a long tone and cancels programming.	<ul style="list-style-type: none"> • Waiting too long between pushing buttons. • Forgetting to press * first when programming.
Keypad is dead.	<ul style="list-style-type: none"> • No power. Check for 16.5 VAC input power. • Check that the keypad is properly connected to the circuit board. The cable on the plug points down when connected to the circuit board.

Symptom	Possible Solution(s)
Buzz or noise on the phone line.	<ul style="list-style-type: none"> • Disconnect the phone line from the system and check it with a handset. If line is noisy, problem is with the phone line and not the entry system. • Check for any shorts to ground behind the circuit board. • Check for pinched wires near the door hinge. • Check for 16-volt power shorted to ground. • Check for phone line shorted to ground. • Check that phone wires are twisted. • Check that the proper type of phone wire was used for an outdoor and / or underground application. • Check that all wires, speaker, keypad, etc. are isolated from ground. • Check that the cabinet is properly grounded. Be sure that case ground (CGND terminal 3) is not used as a low voltage common. • Check for excessive voltage drop on 16 VAC power.
Ringing or howling from the speaker.	<ul style="list-style-type: none"> • Feedback improperly adjusted (2.3.1). • Volume is set too high (2.3.1).
After dial out, dial tone is heard on the speaker.	<ul style="list-style-type: none"> • Phone line is a rotary-dial line. Have the phone company change it to a touch-tone line.
Door strike locks on.	<ul style="list-style-type: none"> • Excessive voltage-drop on 16 VAC line. • Using a transformer with too low VA rating. • Relay strike time programmed too long (3.1.3).
Door strike or gate operator holds open.	<ul style="list-style-type: none"> • Auto relay time zone enabled. Turn auto relay feature off or reprogram the time zone (5.2.5). • System was given a hold open command. Call the system and press the tone deactivate relay number (4.2.5).
Entry system will not answer when called.	<ul style="list-style-type: none"> • Ring pin is not installed (2.3.5). • Number of rings to answer is set to high. Reprogram (3.1.8). • Bad phone line or insufficient ring voltage.
Rotary dial 9 will not activate relay.	<ul style="list-style-type: none"> • Adjust click sensitivity (2.3.2).
Touch-tone 9 will not activate relay.	<ul style="list-style-type: none"> • Re-program tone-open number to 9 (3.1.6). • If resident phone emits a short pulse rather than a long tone, press 9 rapidly twice “99”. • Try another phone that is known to work. • Lower speaker volume and re-adjust feedback (2.3.1).
Relay activates but gate operator will not open.	<ul style="list-style-type: none"> • Re-program relay strike time for a longer period (3.1.3). • Check wiring to gate operator. • Check gate operator.
Postal switch will not activate relay.	<ul style="list-style-type: none"> • Be sure that the wire-tie has been clipped off the postal switch. • Be sure that the relay has been programmed for postal switch input (3.1.7).
Switch input 2 will not activate relay.	<ul style="list-style-type: none"> • Reprogram switch input 2 which only activates relay 2 (3.1.7).
FOUR-digit entry codes will not work.	<ul style="list-style-type: none"> • Forgetting to press “#” first. • Entry code is time zone restricted. Reprogram time zone (3.4.2) or disable time zone (4.2.5). • Entry code attempted was a FLASH entry code that is no longer valid (3.4.5).
FIVE-digit entry codes will not work.	<ul style="list-style-type: none"> • Forgetting to press “#” first. • Entry code is time zone restricted. Reprogram time zone (3.4.2) or disable time zone (4.2.5).
Entry codes will not activate relay 1.	<ul style="list-style-type: none"> • Re-program relay 1 low and high ranges. FOUR-digit codes (3.3.4), FIVE-digit codes (3.3.9).
Entry codes will not activate relay 2.	<ul style="list-style-type: none"> • Re-program relay 1 low and high ranges. FOUR-digit codes (3.3.4), FIVE-digit codes (3.3.9).
System emits a beep every 30 seconds.	<ul style="list-style-type: none"> • Master code switch is in the ON position. Turn master code switch OFF (2.3.4).
LCD is unreadable	<ul style="list-style-type: none"> • Adjust contrast. (2.3.3).

5.3 Accessories

Surge Suppressors

Phone line suppressor. P/N 1877-010.
 Low voltage (28 V) suppressor. P/N 1878-010.
 High voltage (115 V) suppressor. P/N 1879-080.

Mounting Posts & Kiosk

Off-Set pad mount. P/N 1200-036.
 Standard goose-neck, pad mount. P/N 1200-045.
 Standard goose-neck, In-ground mount P/N 1200-046.
 Standard dual-mount. P/N 1200-049.
 Architectural Off-Set mount. P/N 1200-037
 Self-standing Kiosk. P/N 1200-170.

Surface Mount Recess Kit

Use to recess a surface mount unit into a wall or column.
 P/N 1803-150.

Flush Mount Kit

Use to install flush style units into a wall or column. Kit includes rough-in back box and trim-ring. P/N 1814-165 comes with stainless steel trim ring. P/N 1814-166 comes with gold plated trim ring.

Telephone Test Set

Includes clips, cord and carrying case. P/N 1800-050.

DKS Cellular Kit - Voice ONLY

Enables the 1800 series system to send and receive voice ONLY to a phone via DKS Cellular network.
 Voice ONLY - P/N 1801-080

DKS VoIP Adapter Kit

Enables the 1800 series system to send and receive voice via DKS VoIP over IP. P/N 1815-568

Flush Mount Surface Mounting Kit

Use to surface mount a flush style unit. P/N 1814-152.

Stainless Steel Case

Replaces the black steel surface mount case on the 1803 and 1810 units with a stainless steel case. P/N 1810-102.

Back-Up Battery

12 volt .8 amp hour gel cell provides stand by power during power interruptions. P/N 1801-008.

CCTV Camera Kit

High resolution color camera kit. P/N 1812-145.

Secondary Keypads: Allows remote activation of the system relays by use of the access codes. Does not provide any voice communication to the main unit or to the resident telephone. P/N 1812-082 (surface mount); P/N 1812-197 (flush mount).

Wiring Schematic

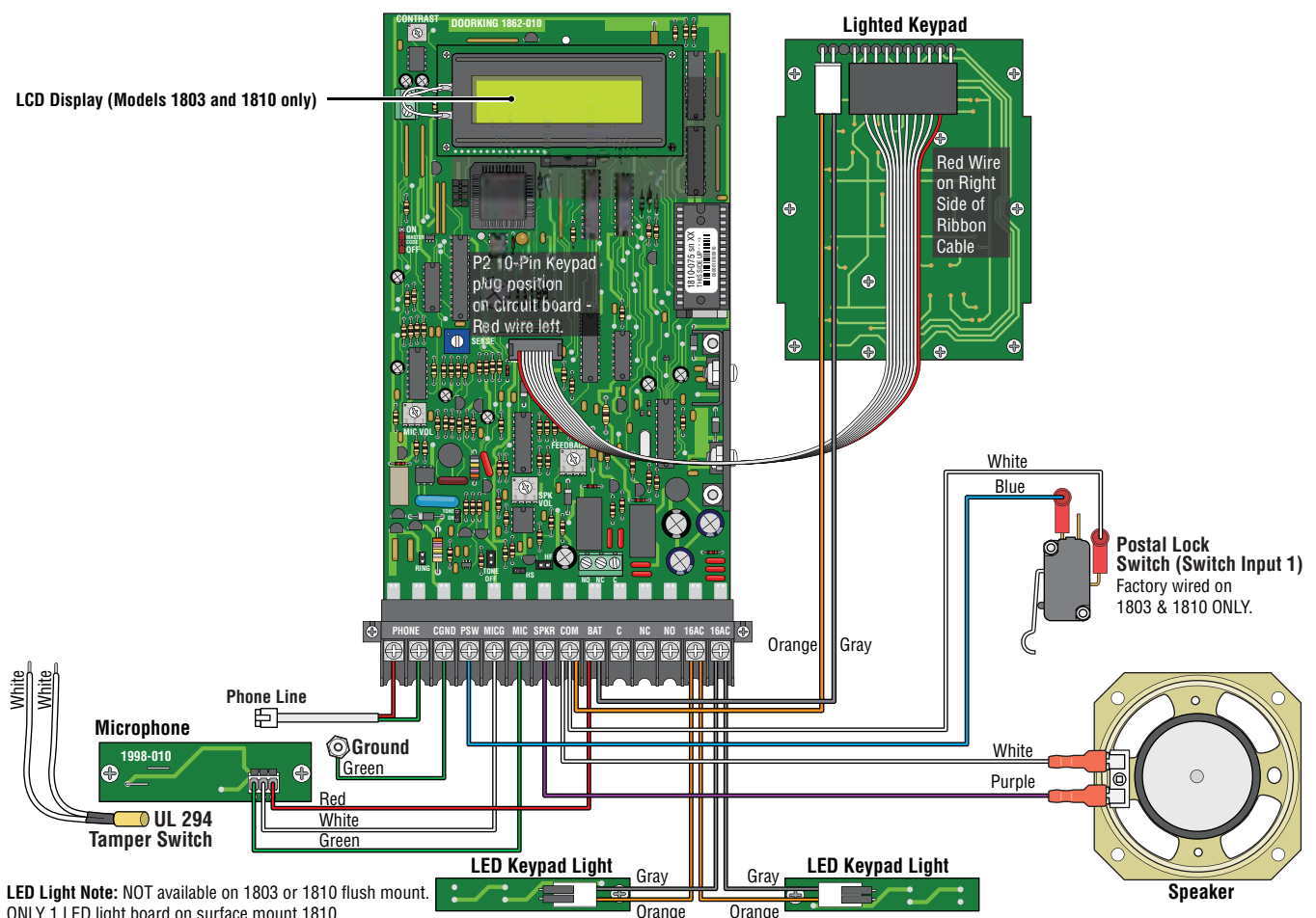

6.1 Log Tables

Complete the information in the tables on the following pages to maintain a record of the information that has been programmed into the telephone entry system.

Master Code (section 3.1.1)			
1st Digit	2nd Digit	3rd Digit	4th Digit

Relay Strike Time (section 3.1.3)	
Relay 1	Relay 2
Factory - 1 sec.	Factory - 1 sec.

Tone Open Numbers (section 3.1.6)	Relay 1	Relay 2
Momentary Activation	Factory - 9	Factory - 5
Relay Hold OPEN	Factory - 8	Factory - 4
Relay RELEASE	Factory - 7	Factory - 3
Relay Hold OPEN 1 Hour	Factory - 6	Factory - 2

Postal Lock Activates (section 3.1.7)	
Switch Input 1-Relay 1	Switch Input 2-Relay 2
Factory Set	

Area Code Reference Number (section 3.2.11)	Area Code
01	
02	
03	
04	
05	
06	
07	
08	

Area Code Reference Number (section 3.2.11)	Area Code
09	
10	
11	
12	
13	
14	
15	

Area Code Note: Used for 7-Digit Phone Numbers Programming ONLY.

Relay 1 Hold Code	Hold Four-Digit Entry Code	Relay 2 Hold Code	Hold Four-Digit Entry Code
1		5	
2		6	
3		7	
4		8	

(section 3.3.5)

Four-Digit Entry Code Divide Number (section 3.3.4)
Factory - 9999

Five-Digit Entry Code Divide Number (section 3.3.9)
Factory - 99999

FOUR-Digit Entry Code Time Zone (section 3.4.3)	
Beginning Time	
Ending Time	
Days of the Week	
Lower Boundary #	
Upper Boundary #	

FIVE-Digit Entry Code Time Zone (section 3.4.4)	
Beginning Time	
Ending Time	
Days of the Week	
Lower Boundary #	
Upper Boundary #	

Automatic Relay Activation Time Zones (section 3.4.2)				
	Zone 1 - Relay 1	Zone 2 - Relay 1	Zone 3 - Relay 2	Zone 4 - Relay 2
Beginning Time				
Ending Time				
Days of the Week				

RESIDENT INSTRUCTIONS



Your building / community has been equipped with a **DoorKing Telephone Entry System** that will provide communication for your guest from the lobby door / gated entrance to your home by use of the local telephone network. If you have any questions regarding the use or operation of this system, please see your **System Administrator** (building manager / HOA representative) or **Call:**

_____ Phone #

Guest Communication: Your name (or apartment number) and telephone number have been programmed into the DoorKing telephone entry system under a specific **DIRECTORY CODE**. This directory code can be from 1 to 4 digits long. When a guest comes to visit you, they will look up your name in a resident directory (located on a separate printed directory to provide guests with the resident directory information). Your **DIRECTORY CODE** will be shown next to your name. Your guest will enter this code on the telephone entry system keypad that will place a call to your home (If your guest already knows **YOUR** specific directory code, they can simply enter the code on the keypad without having to look up your name in the resident directory). **A guest CANNOT enter your telephone number on the keypad, it MUST be the DIRECTORY CODE ONLY!**

Granting or Denying Access to your Guest: Once you have answered the phone call and you have identified your guest, you have the choice to either **grant access** or **deny access** to your guest.

Touch-Tone Phones ONLY.

To **GRANT ACCESS** to your guest, press _____ on your touch-tone telephone. The telephone entry system will respond with a confirmation tone indicating that the door or gate is opening and will automatically disconnect itself. Some newer telephones emit a very short duration tone when the number is pressed. If your telephone does this, you may have to press the "GRANT ACCESS NUMBER" twice in rapid succession to open the door or gate.

To **DENY ACCESS** to your guest, press the "#" key on your touch-tone telephone.

Rotary-Dial Phones ONLY.





To **GRANT ACCESS** to your guest, dial "9".

To **DENY ACCESS** to your guest, **hang-up** your phone.

Call Waiting: If you are on your telephone when a guest tries to contact you from the telephone entry system, they will hear a busy signal and will have to wait for you to end your call before they can contact you. **To eliminate this problem**, you can order call waiting from your local telephone company.

Privacy: If you **DO NOT** want your name and/or apartment number listed in the resident directory, inform the system administrator of this. If you choose this option, you will need to inform your guest what **YOUR directory code** is, otherwise there will be **NO WAY** for them to identify **YOUR** directory code on the resident directory.

Access Code: Your system may be equipped with an "**access code**" that will allow you to open the door / gate by entering this code on the telephone entry system's keypad. Your system administrator will advise you of **YOUR** access code if this option is available.

To use your access code, **first** press the  key, and then enter your four-digit code  .

System Administrator's Note: Fill in the phone number and access granted number above, copy and distribute this sheet to the residents.

Installation/Owner's Manual

1803 / 1808 / 1810

Telephone Entry System

Use this manual for circuit board 1862-010 Revision O or higher.

1800-060 Issued 7-19

Control a main entry point plus an additional entry point.



www.doorking.com

Version B

DoorKing, Inc.
120 S. Glasgow Avenue
Inglewood, California 90301
U.S.A.

Phone: 310-645-0023
Fax: 310-641-1586