

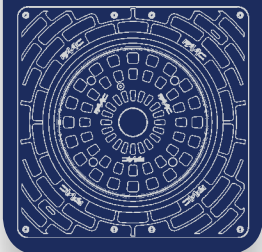

# J SERIES BOLLARDS

**FAAC**  
*Simply automatic.*



# Bollards Series



**FAAC bollards range.  
Endless solutions, performance beyond the standard**

**Innovative solutions to meet  
any application need**

**FAAC Hydraulic Technology,  
over 50 years of worldwide excellence**

**High quality components  
to ensure exceptional performance**

**«Design for Assembly» approach; products  
designed to simplify installation and maintenance**

**The strength of the FAAC Group;  
worldwide presence to support your project**

**Jseries**



## J200 Series for residential areas

### (HA) Automatic

To regulate vehicle access to residential areas

### (SA) Semi-Automatic

To regulate access to areas that are occasionally open to traffic; it doesn't need to be wired.

### (F) Fixed

To complete installations with other retractable models for access control



## J275 Series for commercial, industrial and urban restricted access areas

### (HA) Automatic

To regulate vehicular access to commercial, industrial and urban restricted access areas

### (SA) Semi-Automatic

To regulate vehicle access to town centres, areas that are difficult to wire or occasionally open to traffic

### (F) Fixed

To complete installations with other retractable models for access control



## J355 M30-P1 Series certified perimeter security

### (HA) Automatic

To define, protect and regulate vehicle access to sensitive areas (embassies, military areas, etc.) and, in general, to sites with special security requirements

### (F) Fixed

For the perimeter protection of sensitive areas, in fixed installations or combined with other retractable models



## J355 M50 Series certified perimeter security

### (HA) Automatic

Designed and tested to protect extremely sensitive areas and all those areas with special perimeter security requirements against terroristic attacks

### (F) Fixed

For the perimeter protection of sensitive areas, allows complete aesthetic coherence with automatic models (HA); ideal for mixed installations







# Bollards for residential areas J200

## 1. J200 HA AUTOMATIC RETRACTABLE TRAFFIC BOLLARD

The Automatic retractable traffic bollard FAAC J200 HA is particularly suitable to regulate vehicle traffic in residential areas, ensuring an intelligent control, while maintaining the aesthetic appearance.



# J200



## 2. J200 SA SEMI-AUTOMATIC TRAFFIC BOLLARD

This bollard solves transit and/or parking control problems without needing electrical power (making it particularly suitable for use in historical city centres and areas which are difficult to wire). The bollard is key-operated and automatically lifted by a gas operator. The bollard is lowered by using the same key and pressing on the head.

## 3. J200 F FIXED TRAFFIC BOLLARD

The Fixed traffic bollard FAAC J200 does not require invasive installation work, nor electrical wiring. It is therefore ideal for permanent installations to define residential pedestrian areas, or for mixed installations which also feature other automatic or semi-automatic bollards.





# J200 HA AUTOMATIC retractable traffic bollard

1. Easy to transport, store and install, thanks to the self-supporting structure and to the limited weight of the product
2. Easy underground pit laying and limited excavation
3. A streamlined product, configurable by selecting the desired installation accessories
4. Easy maintenance (can be performed by a single person)
5. Integrated hydraulic unit



## DIMENSIONS AND TECHNICAL SPECIFICATIONS

Item	J200 HA H600	J200 HA H600 INOX
Type of operator	Hydraulic operator	
Cylinder height from ground	600 mm	
Cylinder diameter	200 mm	
Cylinder material	Steel S235JRG2 EN 10277 (6mm thick)	Satin-finished AISI 316L (6mm thick)
Cylinder treatment	Cataphoresis and polyester powder paint, dark grey metallised RAL 7021	Satin finish
Rising time	~5 s (*)	
Descent time	~7 s (*)	
Emergency descent device	YES (optional)	
Emergency descent time	~7 s (*)	
Rising obstacle detection device	YES (optional)	
Release device	SI	
Power supply voltage	220-240V ~ 50/60Hz	
Max. power	230 W (*)	
Hydraulic pump unit protection class	IP67	
Type of use	Use in residential areas	
Total weight	90 Kg	
Operating ambient temperature	-15 °C / +55 °C	
Operating ambient temperature with heater	-25 °C / +55 °C	
Walled in pit with cylinder profile (LxWxH)	400 x 500 x 800 mm	
Dimensioni scavo (LxPxH)	700 x 700 x 1,100 mm	

(\*) Data referred to 230V-50Hz

J200 HA

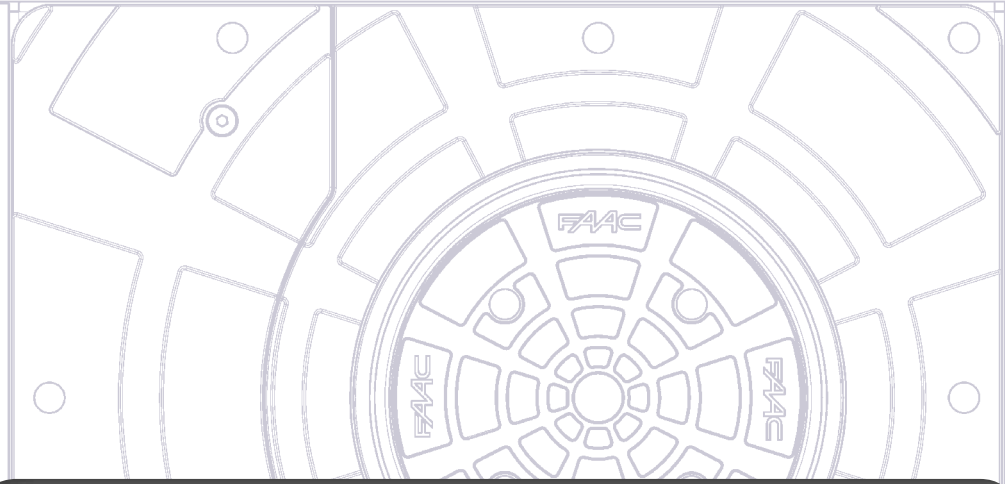

**PAINTED STEEL VERSION**

Model	Height	Finish	Item code
J200 HA 600	600 mm	Painted steel	116500

**The product comes with:**

- 6 mm thick steel cylinder with cathoresis treatment and painted
- powder coated dark grey metallised RAL 7021
- hydraulic lock in raised position (in the event of a power cut) with special release key standard supplied (1 pc.)
- support structure to be cemented with cathoresis treatment (pits not required)

**AISI 316L STAINLESS STEEL VERSION**

Model	Height	Finish	Item code
J200 HA 600	600 mm	satin-finished AISI 316L stainless steel	116505





**The product comes with:**

- 6 mm thick stainless steel cylinder with satin-finish treatment
- hydraulic lock in raised position (in the event of a power cut) with special release key standard supplied (1 pc.)
- support structure to be cemented with cathoresis treatment (pits not required)

**ELECTRONIC EQUIPMENT**

Item	Item code	
Bollard electronic board JE275 able to manage up to three bollards J200 HA	116300	

**OPTIONAL ACCESSORIES**

Item	Item code	
Pit heater J200HA (to extend operation up to -25°C)	116501	
Release kit with pressure switch for J200 HA	116502	
Acoustic buzzer J200 HA	116503	
LED lights kit J200 HA	116504	





# J200 SA SEMI-AUTOMATIC traffic bollard

1. Power supply and wiring not requested
2. Simple and safe movement, thanks to the specific unlocking key
3. Easy to transport, store and install, thanks to the limited weight of the product
4. Kept lock in rised position (against accidental release)



## DIMENSIONS AND TECHNICAL SPECIFICATIONS

Model	J200 SA H600	J200 SA H600 Stainless steel
Type of operator	Single-acting gas operator	
Cylinder height from ground	600 mm	
Cylinder diameter	200 mm	
Cylinder material	Steel S235JRG2 EN 10277 (6mm thick)	Satin-finished AISI 316L (6mm thick)
Cylinder treatment	Cataphoresis and polyester powder paint, dark grey metallised RAL 7021	Satin finish
Release device	Key operated (supplied)	
Reflective strip height	25 mm	
Standard reflecting strip colour	Orange	
Total weight	82 Kg	
Walled in pit with cylinder profile (LxWxH)	400 x 500 x 800 mm	
Excavation dimensions (LxWxH)	700 x 700 x 1,100 mm	

J200 SA



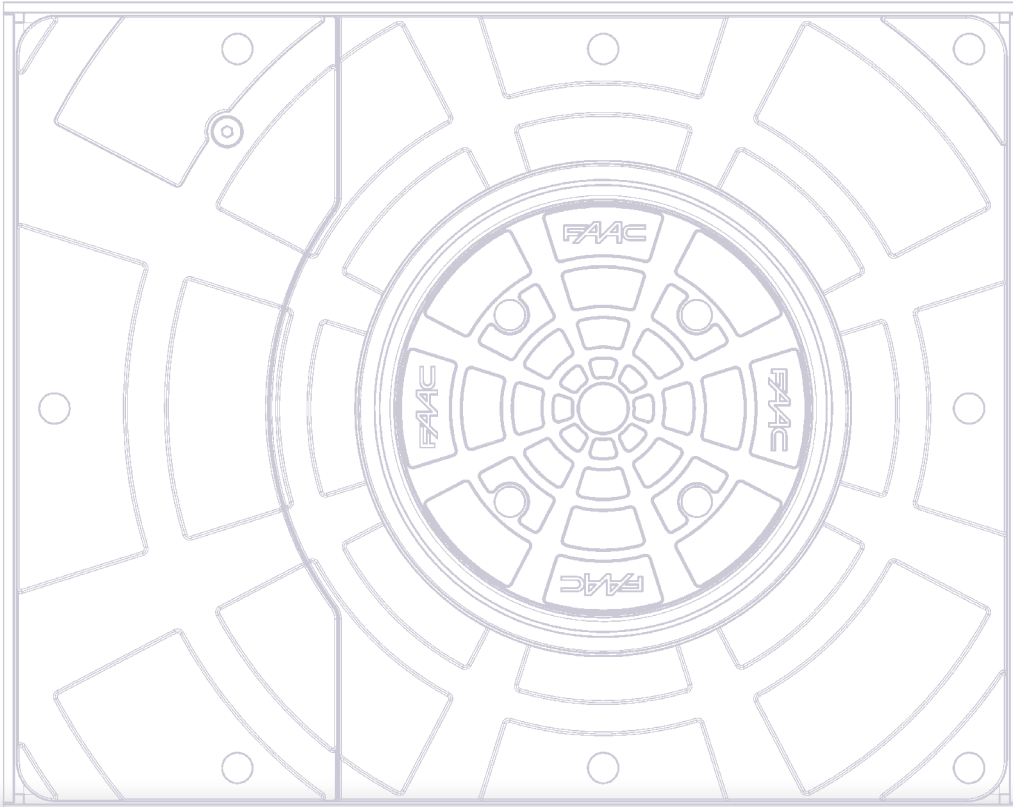

#### PAINTED STEEL VERSION

Model	Height	Finish	Item code
J200 SA 600	600 mm	painting steel	116508

#### The product comes with:

- 6 mm thick steel cylinder with cataphoresis treatment and painting
- powder paint, dark grey metallised RAL 7021
- support structure to be cemented with cataphoresis treatment (pits not required)
- release key (1 piece)

#### AISI 316L STAINLESS STEEL VERSION

Model	Height	Finish	Item code
J200 SA 600	600 mm	satin-finished AISI 316L stainless steel	116509

#### The product comes with:

- 6 mm thick stainless steel cylinder with satin-finished treatment
- support structure to be cemented with cataphoresis treatment (pits not required)
- release key (1 piece)

#### OPTIONAL ACCESSORIES

Item	Item code	
Release keys kit (5 keys)	390084	
LED lights kit J200*	116504	

(\* ) The power supply unit (24 Vdc) and the cable (2x1.5 mm) for the illuminated ring are not supplied.



# J200 F FIXED traffic bollard

1. Power supply and wiring not required
2. Simple installation and limited digging operations
3. Observance of aesthetic consistency in mixed installations with other retractable bollards

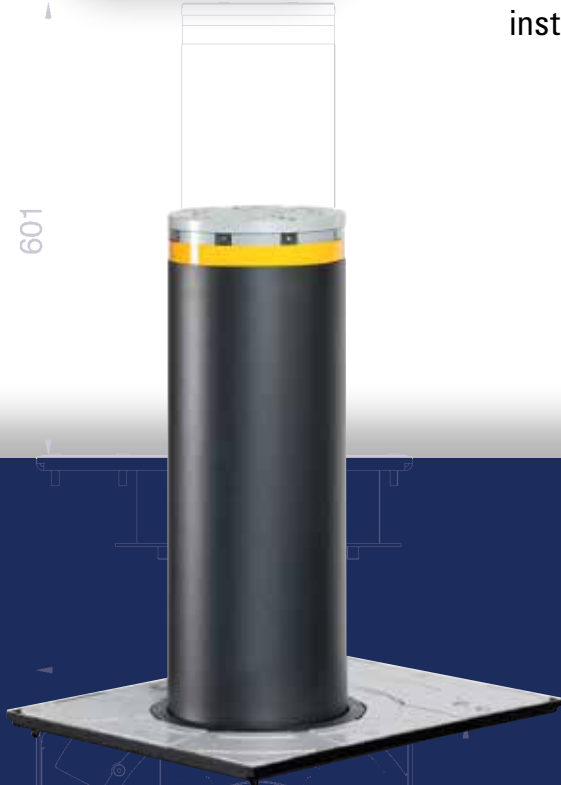

## DIMENSIONS AND TECHNICAL SPECIFICATIONS

Model	J200 F H600	J200 F H600 Stainless steel
Cylinder height from ground	600 mm	
Cylinder diameter	200 mm	
Cylinder material	Steel S235JRG2 EN 10277 (6mm thick)	Satin-finished AISI 316L (6mm thick)
Cylinder treatment	Cataphoresis and polyester powder paint, dark grey metallised RAL 7021	Satin finish
Reflective strip height	25 mm	
Standard reflecting strip colour	Orange	
Total weight	35 Kg	
Walled in pit with cylinder profile (LxWxH)	400 x 500 x 200 mm	
Excavation dimensions (LxWxH)	700 x 700 x 200 mm	

# J200 F



#### PAINTED STEEL VERSION

Model	Height	Finish	Item code
J200 F 600	600 mm	powder paint, dark grey metallised RAL 7021	116506

#### Il prodotto è corredato di:

- 6 mm thick stainless steel cylinder with satin-finished treatment
- Powder paint, dark grey metallised RAL 7021

#### AISI 316L STAINLESS STEEL VERSION

Model	Height	Finish	Item code
J200 F 600	600 mm	satin-finished AISI 316L stainless steel	116507

#### The product comes with:

- 6 mm thick stainless steel cylinder with satin-finished treatment

#### OPTIONAL ACCESSORIES

Item	Item code	
LED lights kit J200*	116504	

(\* ) The power supply unit (24 Vdc) and the cable (2x1.5 mm) for the illuminated ring are not supplied.







# Bollards for commercial, industrial and urban restricted access areas J275

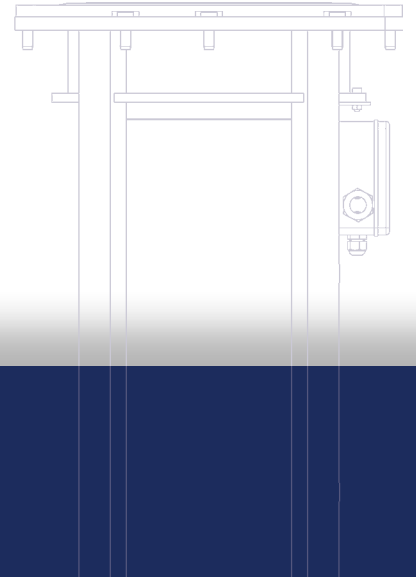
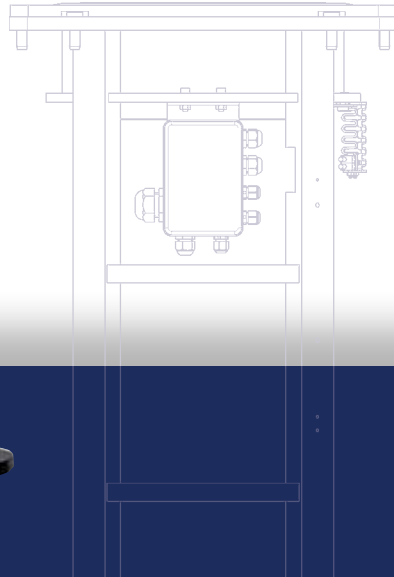

J275



### **1. J275 HA V2 AUTOMATIC RETRACTABLE TRAFFIC BOLLARD**

The Automatic retractable traffic bollard J275 HA V2 is recommended for all areas when many daily transits are expected, i.e. commercial, industrial and urban restricted access areas.

### **2. J275 SA SEMI-AUTOMATIC RETRACTABLE TRAFFIC BOLLARD**

The Semi-Automatic retractable traffic bollard J275 SA is particularly suitable for town centres and areas difficult to wire.

In fact, thanks to a gas actuator, raising and lowering is fully mechanical and does not require any electrical connection.

### **3. J275 F FIXED TRAFFIC BOLLARD**

The Fixed traffic bollard FAAC J275 does not require invasive installation work, nor electrical wiring. It is therefore ideal for permanent installations to define pedestrian areas, or for mixed installations which also feature other retractable bollards.

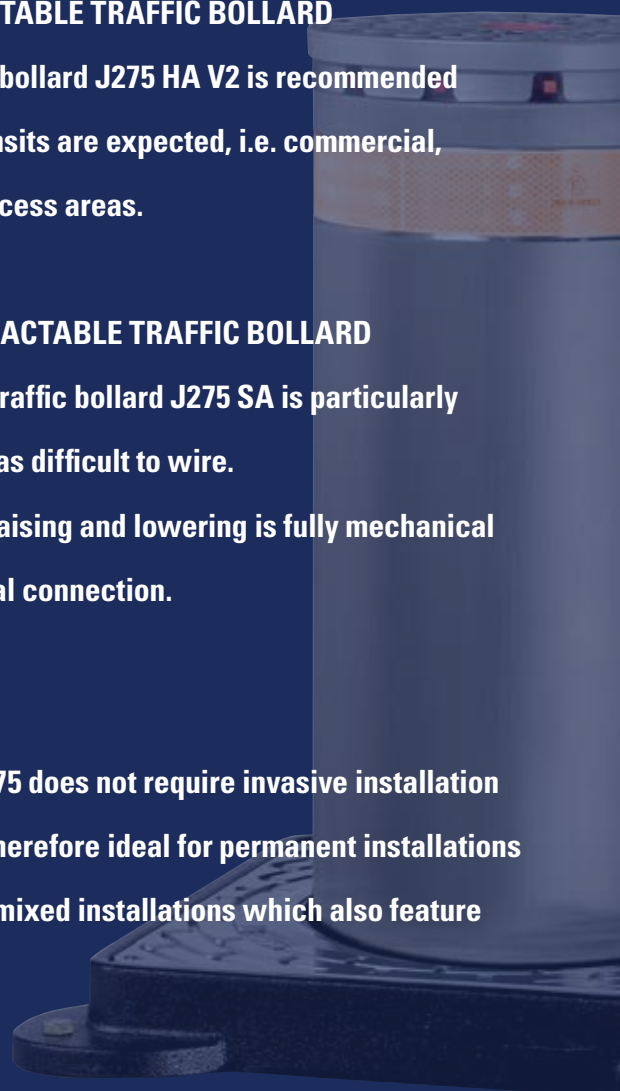





# J275 HA V2 AUTOMATIC retractable traffic bollard

1. Guaranteed for high frequency use
2. "Full optional" product; supplied equipped with the main accessories
3. Simplified maintenance (possible with just one person)
4. Integrated hydraulic unit
5. Perfect interchangeability with first generation bollards
6. "Gentle stop" function to guarantee a soft impact while arriving on the low limit



## DIMENSIONS AND TECHNICAL SPECIFICATIONS

Model	J275 HA V2 H600	J275 HA V2 H800	J275 HA V2 H600 INOX	J275 HA V2 H800 INOX
Type of operator	Hydraulic Actuator			
Cylinder height from ground	600 mm	800 mm	600 mm	800 mm
Cylinder diameter	275 mm			
Cylinder material	Steel S235JR EN 10219 (7mm thick)		Satin-finished AISI 316L (6mm thick)	
Cylinder treatment	Cataphoresis and polyester powder paint, dark grey metallised RAL 7021		Satin finish	
Rising time	~5 s (*)	~7 s (*)	~5 s (*)	~7 s (*)
Descent time	~3.5 s (*)	~4.5 s (*)	~3.5 s (*)	~4.5 s (*)
Emergency descent device	YES (excludable)			
Emergency descent time	~1.2 s (*)	~1.5 s (*)	~1.2 s (*)	~1.5 s (*)
Rising obstacle detection device	YES			
Release device	YES			
Power supply voltage	220-240V ~ 50/60Hz			
Max. power	575 W (*)			
Hydraulic pump unit protection class	IP67			
Type of use	Intensive use (Traffic)			
Impact resistance	38,000 J		67,000 J	
Break in resistance	128,000 J		207,000 J.	
Pit weight	55 Kg	65 Kg	55 Kg	65 Kg
Traffic bollard weight	112 Kg	130 Kg	112 Kg	130 Kg
Operating ambient temperature	-15 °C / +55 °C			
Operating ambient temperature with heater	-25 °C / +55 °C			
Walled in pit with cylinder profile (LxWxH)	560 x 560 x 950 mm	560 x 560 x 1.220 mm	560 x 560 x 950 mm	560 x 560 x 1.220 mm
Excavation dimensions (LxWxH)	1,000 x 1,000 x 1,250 mm	1,000 x 1,000 x 1,540 mm	1,000 x 1,000 x 1,250 mm	1,000 x 1,000 x 1,540 mm
Slow lowering	SI			

(\*) Data referred to 230V-50Hz

J275 HA V2

## ELECTRONIC EQUIPMENT

Item	Item code
Bollard electronic board JE275 able to manage up to three bollards J275 HA	116300





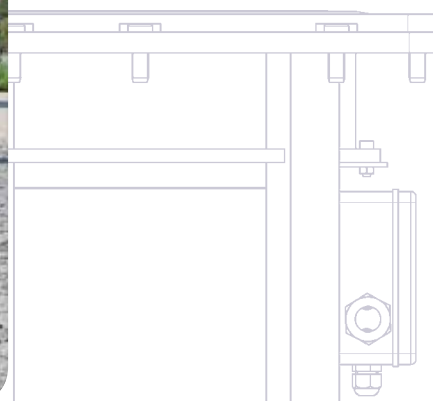

### PAINTED STEEL VERSIONS

Models	Height	Finish	Item code
J275 HA V2 600	600 mm	painted steel	116006
J275 HA V2 800	800 mm		116007

#### The product comes with:

- 7 mm thick steel cylinder with cathaphoresis treatment and painted
- powder paint, dark grey metallised RAL 7021
- flashing light ring with central LED
- acoustic movement buzzer
- emergency lowering in the event of a power cut (can be excluded)
- manual release key for manual emergency lowering (1 pc.)

### AISI 316L STAINLESS STEEL VERSIONS



Models	Height	Finish	Item code
J275 HA V2 600	600 mm	satin-finished AISI 316 L stainless steel	116036
J275 HA V2 800	800 mm		116037

#### The product comes with:

- 6 mm thick stainless steel cylinder with satin-finished treatment
- flashing light ring with central LED
- acoustic movement buzzer
- emergency lowering in the event of a power cut (can be excluded)
- manual release key for manual emergency lowering (1 pc.)





### INSTALLATION ACCESSORIES

Item	Item code	
Pit JP 275/600 for bollard H600 complete with counter frame	1161001	
Pit extension JP 275/800* for bollard H800*	1161011	

(\*) For the 800 mm version the following two elements must be ordered: 116100 + 116101.

### OPTIONAL ACCESSORIES

Item	Item code	
Pit heater JH275 (to extend operation up to -25°C)	116200	
Pit cover JC275	116201	



# J275 SA SEMI-AUTOMATIC retractable traffic bollard

1. Power supply and wiring not required
2. Simple and safe movement, thanks to the specific release key
3. Low position lock guaranteed against accidental release



J275 SA

## DIMENSIONS AND TECHNICAL SPECIFICATIONS

Model	J275 SA H600	J275 SA H600 Stainless steel
Type of operator	Single-acting gas operator	
Cylinder height from ground	600 mm	
Cylinder diameter	275 mm	
Cylinder material	Steel S235JR EN 10219 (7mm thick)	Satin-finished AISI 316L (6mm thick)
Cylinder treatment	Cataphoresis and polyester powder paint, dark grey metallised RAL 7021	Satin finish
Release device	Key operated (supplied)	
Impact resistance	38,000 J	67,000 J
Break in resistance	128,000 J	207,000 J
Pit weight	55 Kg	
Traffic bollard weight	70 Kg	
Walled in pit with cylinder profile (LxWxH)	560 x 560 x 950 mm	
Excavation dimensions (LxWxH)	1,000 x 1,000 x 1,250 mm	



#### PAINTED STEEL VERSION

Model	Height	Finish	Item code
J275 SA 600	600 mm	painted steel	116050

#### The product comes with:

- 7 mm thick steel cylinder with cataphoresis treatment and painted
- powder paint, dark grey metallised RAL 7021
- flashing light ring with central LED\*
- mechanical lock in raised position with special release key (2 pcs.)

#### AISI 316L STAINLESS STEEL VERSION

Model	Height	Finish	Item code
J275 SA 600	600 mm	satin-finished AISI 316L stainless steel	116060

#### The product comes with:

- 6 mm thick stainless steel cylinder with satin-finished treatment
- flashing light ring with central LED\*
- mechanical lock in raised position with special release key (2 pcs.)

(\* ) The power supply unit (24 Vdc) and the cable (2x1.5 mm) for the illuminated ring are not supplied.



#### INSTALLATION ACCESSORIES

Item	Item code	
Pit JP 275/600 for bollard H600 complete with counter frame	1161001	

#### OPTIONAL ACCESSORIES

Item	Item code	
Release keys kit (5 keys)	390084	
Pit cover JC275	116201	





# J275 F FIXED traffic bollard

1. Power supply and wiring not required
2. Simple installation and limited digging operations
3. Observance of aesthetic consistency in mixed installations with other retractable bollards
4. Possibility to remove the bollard to temporarily open the pedestrian area to traffic



741  
601

## DIMENSIONS AND TECHNICAL SPECIFICATIONS

Model	J275 F H600	J275 F H800	J275 F H600 Stainless steel	J275 F H800 Stainless steel
Cylinder height from ground	600 mm	800 mm	600 mm	800 mm
Cylinder diameter	275 mm			
Cylinder material	Steel S235JR EN 10219 (4mm thick)		AISI 316L satin finishing (3mm thickness)	
Cylinder treatment	Cataphoresis and polyester powder paint, dark grey metallised RAL 7021		Satin finish	
Reflective strip height	55 mm			
Standard reflecting strip colour	Orange			
Break in resistance	35,000 J		59,000 J	
Total weight	34 Kg	38 Kg	34 Kg	38 Kg
Walled in pit with cylinder profile (LxWxH)	450 x 450 x 55 mm			
Excavation dimensions (LxWxH)	750 x 750 x 150 mm			

J275 F

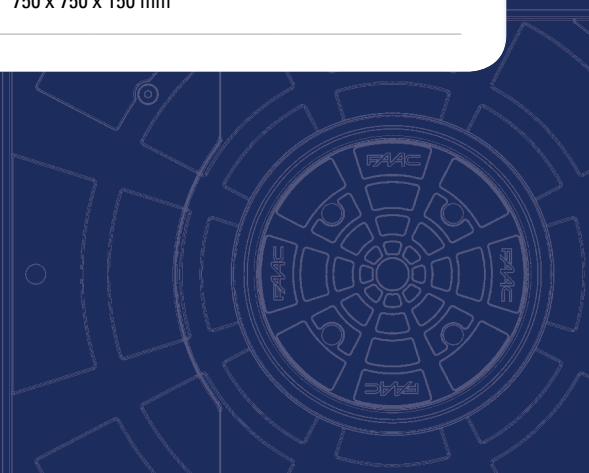



#### PAINTED STEEL VERSIONS

Models	Height	Finish	Item code
J275 F 600	600 mm	painted steel	116020
J275 F 800	800 mm		116021

#### The product comes with:

- a 7 mm steel cylinder cathaphoresis treated and painted
- powder coated dark grey metallised RAL 7021
- flashing light ring with central LED\*

#### AISI 316L STAINLESS STEEL VERSIONS

Models	Height	Finish	Item code
J275 F 600	600 mm	satin-finished AISI 316L stainless steel	116040
J275 F 800	800 mm		116041

#### The product comes with:

- 6 mm thick stainless steel cylinder with satin-finished treatment
- flashing light ring with central LED\*

(\* The power supply unit (24 Vdc) and the cable (2x1.5 mm) for the illuminated ring are not supplied.



#### INSTALLATION ACCESSORIES

Item	Item code	
Fixed bollard fixing frame JPF275	116120	

#### OPTIONAL ACCESSORIES

Item	Item code	
Pit cover JC275	116201	



# J355 bollard certified for use in perimeter security areas

Traffic bollards range specifically dedicated to high security and antiterrorism, ideal to protect every kind of sensitive area and regulate traffic in strategic crossing points

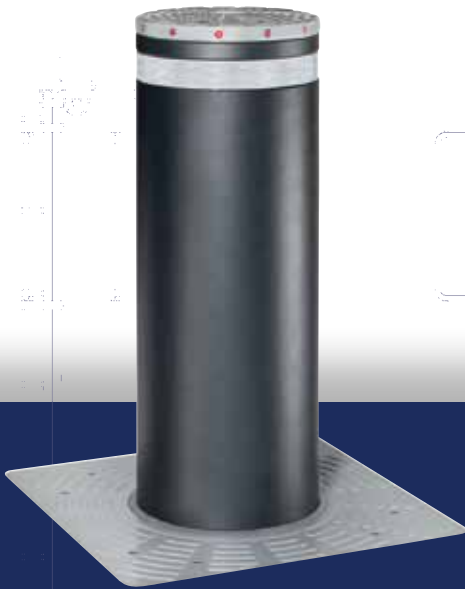

J355



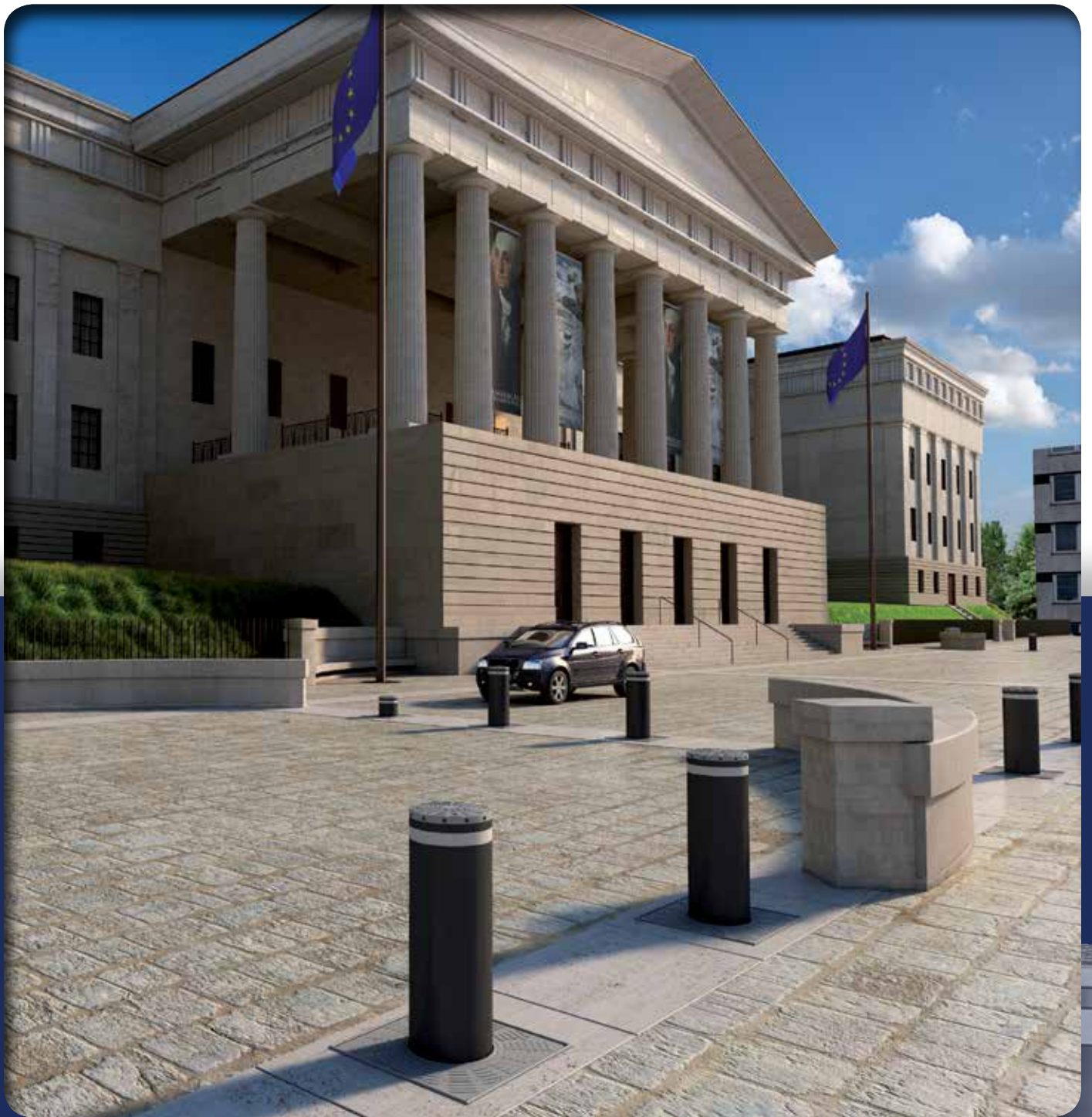



# J355 HA M30-P1 bollard certified for use in perimeter security areas

1. Certified according to ASTM F 2656-07 Standards
2. Impact resistance class M30 IN SINGLE CONFIGURATION
3. Able to stop a 6,800 kg lorry travelling at 50Km/h (=30M/h) with just 1 metre of total penetration (P1)
4. Lock in raised position guaranteed even in the event of a power cut
5. Also available in the EFO (Emergency Fast Operation) version for very fast rise
6. Integrated hydraulic unit



## DIMENSIONS AND TECHNICAL SPECIFICATIONS

Model	J355 HA M30-P1	355 HA M30-P1 Stainless steel	J355 HA M30-P1 EFO	J355 HA M30-P1 EFO Stainless steel
Type of operator	Hydraulic Actuator			
Cylinder height from ground	1,000 mm			
Cylinder diameter	355 mm			
Cylinder material	Steel S355JR EN10210 (16mm thick)			
Cylinder treatment	Cataphoresis and polyester powder paint, dark grey metallised RAL 7021	AISI 316L satin finishing	Cataphoresis and polyester powder paint, dark grey metallised RAL 7021	AISI 316L satin finishing
Rising time	~6 s			
Quick rise device	NO		YES(EFO)	
Emergency rising time	-		~1,5 s	
Descent time	~2 s			
Release device	optional			
Power supply voltage	220-240V ~ 50/60Hz			
Max. power	~2,8 Kw (*)			
Hydraulic pump unit protection class	IP67			
Type of use	Use in security areas			
Max expressed force	5,000 N			
Impact resistance	150,000 J			
Break in resistance	656,000 J			
Pit weight	180 Kg			
Traffic bollard weight	550 Kg	560 Kg	550 Kg	560 Kg
Operating ambient temperature	-15 °C / +55 °C			
Operating ambient temperature with heater	-40 °C / +55 °C			
Walled in pit with cylinder profile (LxWxH)	590 x 670 x 1,665 mm			
Loading class (EN 124)	C25 (25t)			
Excavation dimensions (LxWxH)	3,200 x 1,600 x 1,800 mm			

(\*) Data referred to 230V-50Hz

J355 HA M30



### PAINTED STEEL VERSIONS

Models	Height	Finish	Item code
J355 HA M30	1,000 mm	painted steel	116301
J355 HA M30 EFO			116302

#### The product comes with:

- 16 mm thick steel cylinder with cathaphoresis treatment and painted
- powder coated dark grey metallised RAL 7021
- flashing light ring with central LED
- hydraulic lock in raised position (in the event of a power cut)
- emergency circuit for fast rise (EFO version only)

### AISI 316L STAINLESS STEEL VERSIONS

Models	Height	Finish	Item code
J355 HA M30	1,000 mm	satin-finished AISI 316 L stainless steel	116331
J355 HA M30 EFO			116332

#### The product comes with:

- 16 mm thick steel cylinder with cathaphoresis treatment and satin-finished stainless steel «sleeve»
- flashing light ring with central LED
- hydraulic lock in raised position (in the event of a power cut)
- emergency circuit for fast rise (EFO version only)

### ELECTRONIC EQUIPMENT

Item	Item code	
Bollard electronic board JE275 able to manage up to max 1 bollard J355 HA	116300	

### INSTALLATION ACCESSORIES

Item	Item code	
Pit heater J355 (to extend operation up to -40°C)	116202	
Manual release key	116102	
Pit for J355 HA	116110	







# J355 F M30 bollard certified for use in perimeter security areas

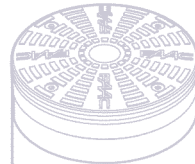

1. Tested according to ASTM F 2656-07 American standards for installations in double units
2. Able to stop a 6,800 kg lorry travelling at 50Km/h (=30M/h)
3. «Shallow Mounted» product: very low excavation depth needed
4. Total aesthetic consistency with other retractable bollards (HA); perfect for mixed installations

J355 F M30

## DIMENSIONS AND TECHNICAL SPECIFICATIONS

Model	J355 F M30	J355 F M30 INOX
Cylinder height from ground		1.000 mm
Cylinder diameter		355 mm
Cylinder material	Steel S355JR EN10210 (16mm thick)	
Cylinder treatment	Cataphoresis and polyester powder paint, dark grey metallised RAL 7021	INOX AISI 316L satin finish
Reflective strip height		55 mm
Standard reflecting strip colour		White
Break in resistance		656,000 J
Total weight		652 Kg
Excavation dimensions (LxWxH)	4,000 x 2,300 x 350mm	

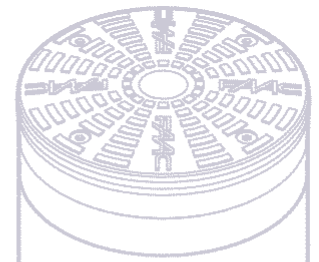

#### PAINTED STEEL VERSION

Model	Height	Finish	Item code
J355 F M30	1,000 mm	painted steel	116321

#### The product comes with:

- 16 mm thick steel cylinder with cathaphoresis treatment and painted
- powder paint, dark grey metallised RAL 7021
- flashing light ring with LED lights\*
- "shallow mount" support structure to be undergrounded

(\* The power supply unit (24 Vdc) and the cable (2x1.5 mm) for the illuminated ring are not supplied.

#### AISI 316L STAINLESS STEEL VERSION

Model	Height	Finish	Item code
J355 F M30	1,000 mm	satin-finished AISI 316L stainless steel	116341

#### The product comes with:

- 16 mm thick steel cylinder with cathaphoresis treatment and satin-finished stainless steel «sleeve»
- flashing light ring with LED lights\*
- "shallow mount" support structure to be undergrounded

(\* The power supply unit (24 Vdc) and the cable (2x1.5 mm) for the illuminated ring are not supplied.

#### INSTALLATION ACCESSORIES

Item	Item code	
Upper cover J355	63000948	



# J355 HA M50 Automatic bollard for use in perimeter security areas

1. Tested according to PAS 68:2013 and IWA 14-1:2013 Standards
2. Impact resistance class N3 7.500-80 in SINGLE CONFIGURATION
3. Able to stop a 7,500 kg lorry travelling at 80Km/h (=50M/h)
4. Raised position lock guaranteed even in the event of a power cut
5. Also available in EFO (Emergency Fast Operation) version for very rapid rising
6. Integrated hydraulic unit

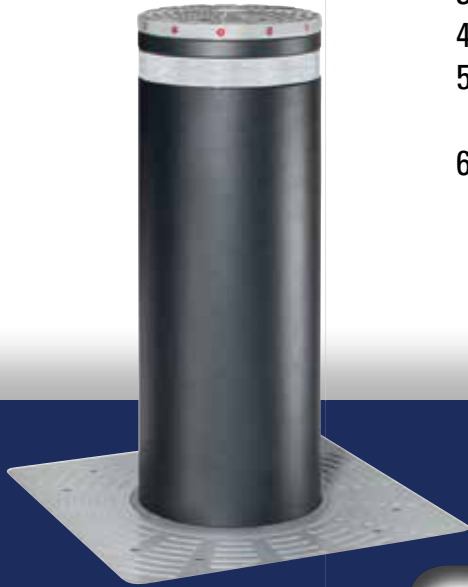

J355 HA M50

## DIMENSIONS AND TECHNICAL SPECIFICATIONS

Model	J355 HA M50	J355 HA M50 INOX	J355 HA M50 EFO	J355 HA M50 EFO INOX
Type of operator	Hydraulic operator			
Cylinder height from ground	1,200 mm			
Cylinder diameter	355 mm			
Cylinder material	Steel S355JR EN 10210 (thickness 30mm)			
Cylinder treatment	Cataphoresis and polyester powder paint, dark grey metallised RAL 7021	AISI 316L satin finishing	Cataphoresis and polyester powder paint, dark grey metallised RAL 7021	AISI 316L satin finishing
Rising time	~6 s (*)			
Quick rise device	NO		YES (EFO)	
Emergency rising time	-		~2 s	
Descent time	(*)	(*)	~3 s	(*)
Release device	optional			
Power supply voltage	220-240V ~ 50/60Hz			
Max. power	(*)			
Hydraulic pump unit protection class	IP67			
Type of use	Use in security areas			
Max expressed force	9,000 N			
Break in resistance	1,852,000 J			
Pit weight	235 Kg			
Traffic bollard weight	850 Kg			
Operating ambient temperature	-15 °C / +55 °C			
Operating ambient temperature with heater	-40 °C / +55 °C			
Excavation dimensions (LxWxH)	3.100 x 1.600 x 1.850 mm			

(\*) Data referred to 230V-50Hz





### PAINTED STEEL VERSIONS

Models	Height	Finish	Item code
J355 HA M50	1,200 mm	painted steel	116351
J355 HA M50 EFO			116352

#### The product comes with:

- 30 mm thick steel cylinder with cataphoresis treatment and painted
- powder coated dark grey metallised RAL 7021
- flashing light ring with central LED
- hydraulic lock in raised position (in the event of a power cut)
- emergency circuit for fast rise (EFO version only)

### AISI 316L STAINLESS STEEL VERSIONS

Models	Height	Finish	Item code
J355 HA M50	1,200 mm	satin-finished AISI 316 L stainless steel	116381
J355 HA M50 EFO			116382



#### The product comes with:

- 30 mm thick steel cylinder with cataphoresis treatment and satin-finished stainless steel «sleeve»
- flashing light ring with central LED
- hydraulic lock in raised position (in the event of a power cut)
- emergency circuit for fast rise (EFO version only)

### ELECTRONIC EQUIPMENT

Item	Item code	
Bollard electronic board JE275 able to manage up to max 1 bollard J355 HA	116300	

### INSTALLATION ACCESSORIES

Item	Item code	
Pit heater J355 (to extend operation up to -40°C)	116202	
Pit for J355 HA	116130	

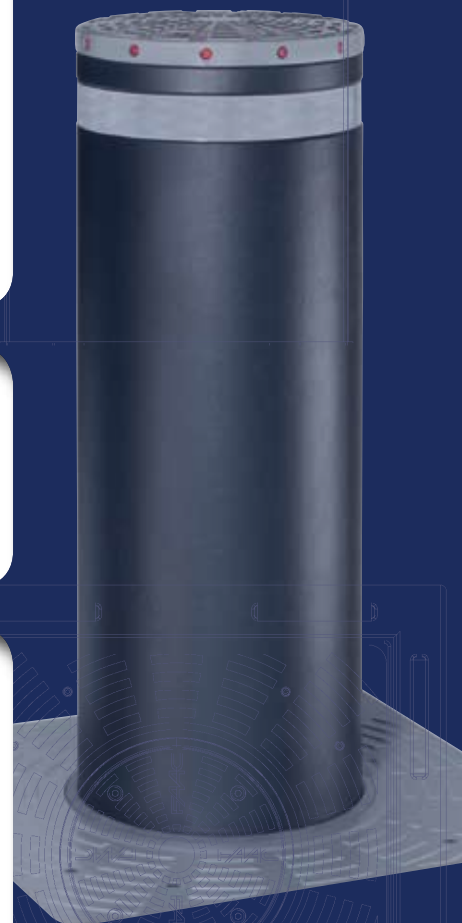



# J355 F M50 Fixed bollard for use in perimeter security areas

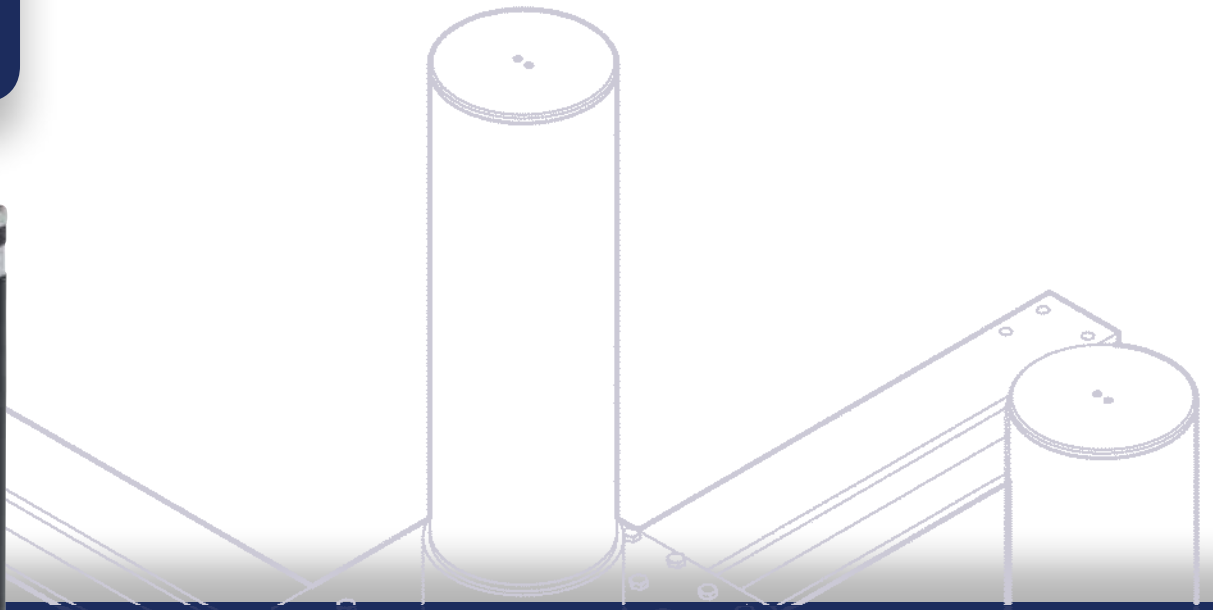

1. Tested according to ASTM F 2656-07 american standards for installations in triple units.
2. Able to stop a 7,500 kg lorry travelling at 80Km/h (=50M/h).
3. «Shallow Mounted» product: very low excavation depth needed.
4. Total aesthetic consistency with other retractable bollards (HA); ideal for mixed installations.

J355 F M50

## DIMENSIONS AND TECHNICAL SPECIFICATIONS

Model	J355 F M50	J355 F M50 INOX
Cylinder height from ground	1,200 mm	
Cylinder diameter	355 mm	
Cylinder material	Steel S355JR EN10210 (16mm thick)	
Cylinder treatment	Cataphoresis and polyester powder paint, dark grey metallised RAL 7021	INOX AISI 316L satin finish
Reflective strip height	55 mm	
Standard reflecting strip colour	White	
Break in resistance	1,680,000 J	
Total weight	680 Kg	
Excavation dimensions (LxWxH)	4,000 x 2,300 x 350mm	

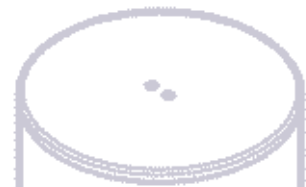

#### PAINTED STEEL VERSION

Model	Height	Finish	Item code
J355 F M50	1,200 mm	painting steel	116371

#### The product comes with:

- 16 mm thick steel cylinder with cathoresis treatment and painted
- powder paint, dark grey metallised RAL 7021
- flashing light ring with led lights\*
- "shallow mount" support structure to be undergrounded

(\* ) The power supply unit (24 Vdc) and the cable (2x1.5 mm) for the illuminated ring are not supplied.

#### AISI 316 STAINLESS STEEL VERSION

Model	Height	Finish	Item code
J355 F M50	1,200 mm	satin-finished AISI 316 L stainless steel	116391

#### The product comes with:

- 16 mm thick steel cylinder with cathoresis treatment and satin-finished stainless steel «sleeve»
- flashing light ring with led lights\*
- "shallow mount" support structure to be undergrounded

(\* ) The power supply unit (24 Vdc) and the cable (2x1.5 mm) for the illuminated ring are not supplied.



#### INSTALLATION ACCESSORIES

Item	Item code	
Upper cover J355	63000948	



## J200 SERIES

DIAMETER	200 mm
HEIGHT	600 mm
FINISH	PAINTED STEEL, SATIN-FINISHED STAINLESS STEEL
VERSIONS	AUTOMATIC (HA); SEMI-AUTOMATIC (SA); FIXED (F)



## J355 M30 SERIES

DIAMETER	355 mm
HEIGHT	1,000 mm
FINISH	PAINTED STEEL, SATIN-FINISHED STAINLESS STEEL
VERSIONS	AUTOMATIC (HA); AUTOMATIC + EMERGENCY FAST OPERATION (HA EFO); FIXED (F)



## J275 SERIES

DIAMETER	275 mm
HEIGHT	600 mm - 800 mm
FINISH	PAINTED STEEL, SATIN-FINISHED STAINLESS STEEL
VERSIONS	AUTOMATIC (HA); SEMI-AUTOMATIC (SA); FIXED(F)



## J355 M50 SERIES

DIAMETER	355 mm
HEIGHT	1,200 mm
FINISH	PAINTED STEEL, SATIN-FINISHED STAINLESS STEEL
VERSIONS	AUTOMATIC (HA); AUTOMATIC + EMERGENCY FAST OPERATION (HA EFO); FIXED (F)





## HEADQUARTERS

### ITALY

FAAC S.p.A. - Soc. Unipersonale  
Via Calari 10 - 40069 Zola Predosa (BO)  
Tel. +39 051 61724 - Fax +39 051 758518  
it.info@faacgroup.com - www.faacgroup.com

## SUBSIDIARIES

### ASIA - PACIFIC

FAAC MALAYSIA  
Selangor, Malaysia  
tel. +60 3 5123 0033  
www.faac.international

### AUSTRALIA

FAAC AUSTRALIA PTY LTD  
Homebush – Sydney, Australia  
tel. +61 2 87565644  
www.faac.com.au

### AUSTRIA

FAAC GMBH  
Salzburg, Austria  
tel. +43 662 85333950  
www.faac.at

FAAC BV - TUBULAR MOTORS  
Doetinchem, The Netherlands  
tel. +49 30 5679 6645  
faacbv.info@faacgroup.com  
www.faac-tubularmotors.com

### BENELUX

FAAC BENELUX NV/SA  
Brugge, Belgium  
tel. +32 50 320202  
www.faacbenelux.com

FAAC BV  
Doetinchem, The Netherlands  
tel. +31 314 369911  
faacbv.info@faacgroup.com  
www.faacbv.com

### BRAZIL

INDÚSTRIAS ROSSI ELETROMECAÂNICA SA  
Brasília DF, Brazil  
tel. +55 61 33998787  
www.rossiportoes.com.br

### CHINA

FAAC SHANGHAI  
Shanghai, China  
tel. +86 21 68182970  
www.faacgroup.cn

### FRANCE

FAAC FRANCE  
Saint Priest - Lyon, France  
tel. +33 4 72213020  
www.faac.fr

FAAC FRANCE - AGENCE PARIS  
Massy - Paris, France  
tel. +33 4 72213020  
www.faac.fr

FAAC FRANCE - DEPARTEMENT VOLETS  
Saint Denis de Pile - Bordeaux, France  
tel. +33 5 57551890  
www.faac.fr

### GERMANY

FAAC GMBH  
Freilassing, Germany  
tel. +49 8654 49810  
www.faac.de

FAAC BV - TUBULAR MOTORS  
Doetinchem, The Netherlands  
tel. +49 30 5679 6645  
faacbv.info@faacgroup.com  
www.faac-tubularmotors.com

### INDIA

FAAC INDIA PVT. LTD  
Noida – Delhi, India  
tel. +91 120 3934100/4199  
www.faacindia.com

### IRELAND

NATIONAL AUTOMATION LTD  
Co. Roscommon, Ireland  
tel. +353 71 9663893  
www.nal.ie

### MIDDLE EAST

FAAC MIDDLE EAST FZE  
Dubai Silicon Oasis Operation Center - Dubai, UAE  
tel. + 971 4 3724190  
www.faac.ae

### POLAND

FAAC POLSKA SP.ZO.O  
Warszawa, Poland  
tel. +48 22 8141422  
fax +48 22 8142024  
www.faac.pl

### RUSSIA

FAAC RUSSIA  
Moscow, Russia  
tel. +7 (495) 646 24 29  
www.faac.ru

### SCANDINAVIA

FAAC NORDIC AB  
Perstorp, Sweden  
tel. +46 435 779500  
www.faac.se

### SOUTH AFRICA

FAAC SOUTH AFRICA  
2040 Johannesburg  
tel. +27 11 794 4525  
www.faac.international

### SPAIN

CLEM, S.A.U.  
San Sebastián de los Reyes - Madrid, Spain  
tel. +34 91 3581110  
www.faac.es

### SWITZERLAND

FAAC AG  
Altdorf, Switzerland  
tel. +41 41 8713440  
www.faac.ch

### TURKEY

FAAC OTOMATİK GEÇİŞ SİSTEMLERİ  
SAN. VE TİC. LTD. SIRTEKI  
İstanbul, Turkey  
tel. +90 (0)212 - 3431311  
www.faac.com.tr

### UNITED KINGDOM

FAAC UK LTD.  
Basingstoke Hampshire, UK  
tel. +44 1256 318100  
www.faac.co.uk

### U.S.A.

FAAC INTERNATIONAL INC  
Rockledge, FL - U.S.A.  
tel. +1 866 925 3222  
www.faacusa.com

FAAC INTERNATIONAL INC  
Fullerton, California - U.S.A.  
tel. +1 714 446 9800  
www.faacusa.com

**FAAC**  
Simply automatic.

FAAC S.p.A. - Soc. Unipersonale  
Via Calari 10 - 40069 Zola Predosa (BO)  
Tel. +39 051 61724 - Fax +39 051 758518  
it.info@faacgroup.com - www.faac.it

